



# Instruction Manual



## **EL-FLOW<sup>®</sup> Prestige series Thermal Mass Flow Meters/Controllers**

Doc. no.: 9.17.084 rev. S    Date: 14-06-2023



### **ATTENTION**

Please read this document carefully before installing and operating the product.  
Not following the guidelines could result in personal injury and/or damage to the equipment.  
Keep this document for future reference.



## Copyright

© 2023 Bronkhorst High-Tech B.V. - All rights reserved.

Bronkhorst® is a registered trademark of Bronkhorst High-Tech B.V.  
All other trademarks are the property of their respective owners.

## Disclaimer

The illustrations in this document serve to provide general notices regarding correct operation. The illustrations are simplified representations of the actual situation and may differ from the actual product.

Bronkhorst High-Tech B.V. reserves the right to modify or improve its products and documentation without notice. Prior to work, check whether a newer version of this document is available on the Bronkhorst website.

## Symbols in this document



*Important information. Disregarding this information could increase the risk of damage to the equipment, or the risk of personal injuries.*



*Tips, useful information, attention points. This will facilitate the use of the instrument and/or contribute to its optimal performance.*



*Additional information available in the referenced documentation, on the indicated website(s) or from your Bronkhorst representative.*

## Receipt of equipment

Check the outside packaging box for damage incurred during shipment. If the box is damaged, the local carrier must be notified at once regarding his liability. At the same time a report should be submitted to your Bronkhorst representative.

Carefully remove the equipment from the box. Verify that the contents of the package was not damaged during shipment. Should the equipment be damaged, the local carrier must be notified at once regarding his liability. At the same time a report should be submitted to your Bronkhorst representative.

If the product is damaged, it should not be put into service. In that case, contact your Bronkhorst representative for service.



- *Check the packing list to ensure that you received all items included in the scope of delivery.*
- *Do not discard spare or replacement parts.*

See [Removal and return instructions](#) for information about return shipment procedures.

## Equipment storage

- The equipment should be stored in its original package in a climate controlled storage location.
- Care should be taken not to subject the equipment to excessive temperatures or humidity.
- See technical specifications (data sheet) for information about required storage conditions.

## Warranty

Bronkhorst® products are warranted against defects in material and workmanship for a period of three years from the date of shipment, provided they are used in accordance with the ordering specifications and not subject to abuse or physical damage. Products that do not operate properly during this period may be repaired or replaced at no charge. Repairs are normally warranted for one year or the balance of the original warranty, whichever is the longer.



See also section 9 (Guarantee) of the Conditions of sales:  
[www.bronkhorst.com/int/about/conditions-of-sales/](http://www.bronkhorst.com/int/about/conditions-of-sales/)

The warranty includes all initial and latent defects, random failures, and indeterminable internal causes. It excludes failures and damage caused by the customer, such as contamination, improper electrical hook-up, physical shock etc.

Re-conditioning of products primarily returned for warranty service that is partly or wholly judged non-warranty may be charged for.

Bronkhorst High-Tech B.V. or affiliated company prepays outgoing freight charges when any part of the service is performed under warranty, unless otherwise agreed upon beforehand. The costs of unstamped returns are added to the repair invoice. Import and/or export charges as well as costs of foreign shipping methods and/or carriers are paid by the customer.

## General safety precautions

This product is intended for use by qualified personnel who recognize shock hazards and are familiar with the safety precautions required to prevent possible injury. Read the operating information carefully before using the product.

Before operating, make sure the line cord is connected to a properly grounded power receptacle. Inspect the connecting cables for cracks or breaks before each use.

The equipment and accessories must be used in accordance with their specifications and operating instructions, otherwise the safety of the equipment may be impaired.

Opening the equipment is not allowed. There are no user serviceable parts inside. In case of a defect please return the equipment to Bronkhorst High-Tech B.V.

One or more warning signs may be attached to the product. These signs have the following meaning:



*General warning; consult the instruction manual for handling instructions*



*Surface may get hot during operation*



*Shock hazard; electrical parts inside*

To maintain protection from electric shock and fire, replacement components must be obtained from Bronkhorst. Standard fuses, with applicable national safety approvals, may be used if the rating and type are the same. Non-safety related components may be obtained from other suppliers, as long as they are equivalent to the original component. Selected parts should be obtained only through Bronkhorst, to maintain accuracy and functionality of the product. If you are unsure about the suitability of a replacement component, contact your Bronkhorst representative for information.



## Table of contents

<b>1</b>	<b>Introduction .....</b>	<b>7</b>
1.1	Scope of this manual .....	7
1.2	Intended use .....	7
1.3	Product description .....	7
1.3.1	EL-FLOW® Prestige PI .....	8
1.4	Documentation .....	9
1.5	Model key .....	10
<b>2</b>	<b>Starting up .....</b>	<b>12</b>
2.1	Functional properties .....	12
2.2	Operating conditions .....	12
2.3	Mounting .....	12
2.4	Piping requirements .....	13
2.5	Fluid connection .....	13
2.6	Electrical connection .....	13
2.7	Analog / digital communication .....	14
2.7.1	Analog / local communication .....	14
2.7.2	Digital RS232 communication .....	14
2.7.3	Digital RS485 / fieldbus communication .....	15
2.8	Micro switch operation .....	15
2.9	Powering up and powering down .....	15
2.10	First use .....	15
2.11	Calibration .....	15
2.12	Maintenance .....	16
<b>3</b>	<b>Basic operation .....</b>	<b>17</b>
3.1	Mass flow measurement and control .....	17
3.1.1	Changing fluid set, range or operating conditions .....	17
3.1.2	Valve Safe State .....	19
3.2	Communication interfaces .....	19
3.2.1	Using multiple interfaces .....	19
3.3	Analog operation .....	20
3.3.1	Cabling .....	20
3.4	Basic RS232 operation .....	20
3.4.1	Cabling .....	21
3.4.1.1	RS232 communication .....	21
3.4.1.2	RS232 communication powered by fieldbus .....	22
3.4.1.3	E-8000 power supply, readout and control .....	22
3.4.1.4	BRIGHT readout and control .....	23
3.4.2	FlowDDE .....	23
3.4.3	Software (DDE applications) .....	24
3.4.4	Baud rate setup .....	24
3.5	Basic RS485 operation (FLOW-BUS/Modbus) .....	25
3.5.1	Cabling .....	26
3.5.2	Software .....	27
3.5.3	Baud rate, node address and parity setup .....	27
3.6	Other fieldbus configurations .....	28
3.6.1	Baud rate, node address and parity setup .....	29

3.7	LED indications .....	29
3.8	Micro switch functions .....	31
3.8.1	Normal operating functions .....	31
3.8.2	Power-up functions .....	32
3.8.3	Control mode - readout/change .....	32
3.8.4	Network settings - readout/change .....	33
3.9	Basic parameters and properties .....	34
3.9.1	General .....	34
3.9.2	Measurement and control (basic) .....	35
3.9.2.1	Secondary outputs .....	36
3.9.3	Device identification .....	36
3.9.4	Alarms and counter .....	37
3.10	Adjusting zero point .....	37
3.10.1	Manual procedure .....	38
3.10.2	Digital procedure .....	38
<b>4</b>	<b>Advanced operation .....</b>	<b>39</b>
4.1	Sealing material compatibility .....	39
4.2	Advanced parameters and properties .....	40
4.2.1	Measurement and control (advanced) .....	40
4.2.2	Special parameters .....	41
4.2.3	Fluid set .....	42
4.2.3.1	Advanced fluid set parameters .....	44
4.2.3.2	Fluid mixture parameters .....	45
4.2.4	Alarms .....	46
4.2.5	Counter .....	48
4.2.6	Network configuration .....	49
4.2.7	Master/slave configuration (FLOW-BUS) .....	50
4.3	Special features .....	51
4.3.1	Customized I/O options (pin 5) .....	51
4.3.2	Changing default control mode .....	53
<b>5</b>	<b>Troubleshooting and service .....</b>	<b>54</b>
5.1	Errors and warnings .....	54
5.2	Restoring factory settings .....	54
5.3	Common issues .....	55
5.4	Service .....	56
<b>6</b>	<b>Returns .....</b>	<b>57</b>
6.1	Removal and return instructions .....	57
6.2	Disposal (end of lifetime) .....	57
	<b>Parameter index .....</b>	<b>59</b>

# 1 Introduction

## 1.1 Scope of this manual

This manual covers the **EL-FLOW® Prestige** series mass flow meters/controllers for gases. This manual includes product information, installation instructions, operation, maintenance and troubleshooting tips.



## 1.2 Intended use

**EL-FLOW® Prestige** instruments are designed to accurately measure and/or control gas flow rates of a specified gas at the conditions stated on the serial number label. The gas in the pressurized system in which the instrument is mounted has to be clean and dry. The instruments are suited for general purpose indoor (dry) applications, like laboratories and machine enclosures. The instruments can be used for either (fast) switching gas flow or for controlling a constant flow rate (mass flow controllers only).



*The wetted materials incorporated in the EL-FLOW® Prestige are compatible with media and conditions (e.g. pressure, temperature) as specified at ordering time. If you are planning to use the product (including any third party components supplied by Bronkhorst, such as pumps or valves) with other media and/or other conditions, always check the wetted materials (including seals) for compatibility. See the technical specifications of the product and consult third party documentation (if applicable) to check the incorporated materials.*

*Responsibility for the use of the equipment with regard to its intended use, suitability for the intended application, cleaning and compatibility of process media with the applied materials lies solely with the user.*

*The user is responsible for taking the necessary safety measures to prevent damage and/or injury while working with the equipment and process media (as described in the associated Material Safety Data Sheets).*

*Where appropriate, this document recommends or prescribes safety measures to be taken with respect to media usage or working with the described equipment under the specified conditions. However, this does not relieve the user of aforementioned responsibility, not even if such is not explicitly recommended or prescribed in this document.*

*Bronkhorst High-Tech B.V. cannot be held liable for any damage and/or injury resulting from unintended, improper or unsafe use, or use with other media and/or under other process conditions than specified at ordering time.*

## 1.3 Product description

**EL-FLOW® Prestige** is the next generation of Bronkhorst® Mass Flow Meters/ Controllers using the latest, highly accurate, thermal by-pass sensor technology and featuring excellent control characteristics. Thanks to the advanced sensor technology in combination with a state-of-the-art printed circuit board, the instruments feature improved long-term stability as well as an unsurpassed temperature stability. Furthermore, due to a power efficient microprocessor, the power consumption of the instrument is reduced. The mass flow meters and controllers can be supplied in full scale ranges from 0,7 ml<sub>n</sub>/min up to 100 l<sub>n</sub>/min Air-equivalent at max. 64 or 100 bar (1000 or 1500 psi) pressure rating.

**EL-FLOW® Prestige** offers high flexibility due to the multi-gas/multi-range functionality. This function, now extended to 100 gases and mixtures thereof, is easily accessible via the FlowTune™ software or PLC; there is no need to disconnect the instrument from your system. For additional gas types the user can calculate accurate fluid properties for conversion by means of our free, online software tool FLUIDAT® on the Net. Users of **EL-FLOW® Prestige** instruments can rescale their instruments on site, saving time and money for dismantling and recalibration.

Numerous input/output options can be installed through the programmable 9-pin D-sub connector (from factory). In addition to the various analog signal options and the standard RS232 communication, there are such options as RS485 communication, digital frequency/pulse output, alarm output/reset, valve purge/close and analog valve output. Furthermore Bronkhorst offers various integrated fieldbus options: DeviceNet™, PROFIBUS DP, Modbus RTU/ASCII, EtherCAT®, PROFINET and FLOW-BUS.

### 1.3.1 EL-FLOW® Prestige PI

The **EL-FLOW® Prestige PI** (pressure insensitive) adds active pressure compensation to the already very accurate controlling characteristics, resulting in even more accurate flow measurement and control stability.

An innovative static compensation algorithm ('FLUIDAT On Board') uses the actual fluid temperature and pressure to calculate fluid properties in real time. Density, viscosity, thermal conductivity and heat capacity of the processed media change under the influence of pressure and temperature. The Fluidat On Board algorithm continuously recalculates these properties and uses them to adjust the gas flow.

Dynamic pressure compensation detects rapid and large pressure changes (caused, for instance, by operating multiple flow devices on the same fluid line, also called the Crosstalk Pressure Effect) and adjusts the control signal in such a way that the gas flow remains stable.

The **EL-FLOW® Prestige PI** is available with a choice from two different pressure sensors (up to 10 bar(g) and up to 100 bar(g)), both of which apply static compensation. The 10 bar type also uses dynamic compensation.





## 1.4 Documentation

The EL-FLOW® Prestige comes with all necessary documentation for basic operation and maintenance. Some parts of this manual refer to other documents, most of which can be downloaded from the Bronkhorst website. A calibration certificate for each ordered instrument is part of the scope of delivery.



The documentation listed in the following table is available on the **EL-FLOW® Prestige** product pages under [www.bronkhorst.com/products](http://www.bronkhorst.com/products)

Type	Document name	Document no.
Manuals	Instruction Manual EL-FLOW® Prestige (this document)	9.17.084
	Quick Installation Guide EL-FLOW® Prestige	9.17.083
Technical documentation	Hook-up diagram Analog/RS232	9.16.119
	Hook-up diagram CANopen	9.16.217
	Hook-up diagram DeviceNet™	9.16.122
	Hook-up diagram EtherCAT®	9.16.124
	Hook-up diagram EtherNet/IP	9.16.215
	Hook-up diagram FLOW-BUS	9.16.120
	Hook-up diagram Modbus ASCII / RTU	9.16.123
	Hook-up diagram Modbus TCP	9.16.234
	Hook-up diagram POWERLINK	9.16.236
	Hook-up diagram PROFIBUS DP	9.16.121
	Hook-up diagram PROFINET	9.16.147
	Hook-up diagram custom bus & I/O configurations	9.16.118
	Dimensional drawing	model specific



The documentation listed in the following table can be downloaded from [www.bronkhorst.com/downloads](http://www.bronkhorst.com/downloads)

Type	Document	Document no.
General documentation	EU Declaration of Conformity	9.06.021
Manuals	Manual EtherNet/IP	9.17.132
	Manual CANopen interface	9.17.131
	Manual DeviceNet™ interface	9.17.026
	Manual EtherCAT® interface	9.17.063
	Manual FLOW-BUS interface	9.17.024
	Manual Modbus interface ASCII / RTU / TCP	9.17.035
	Manual POWERLINK interface	9.17.142
	Manual PROFIBUS DP interface	9.17.025
	Manual PROFINET interface	9.17.095
	Manual RS232 interface	9.17.027

## 1.5 Model key

The model key on the serial number label contains information about the technical properties of the instrument as ordered. The actual properties of your instrument can be retrieved from the diagram below.

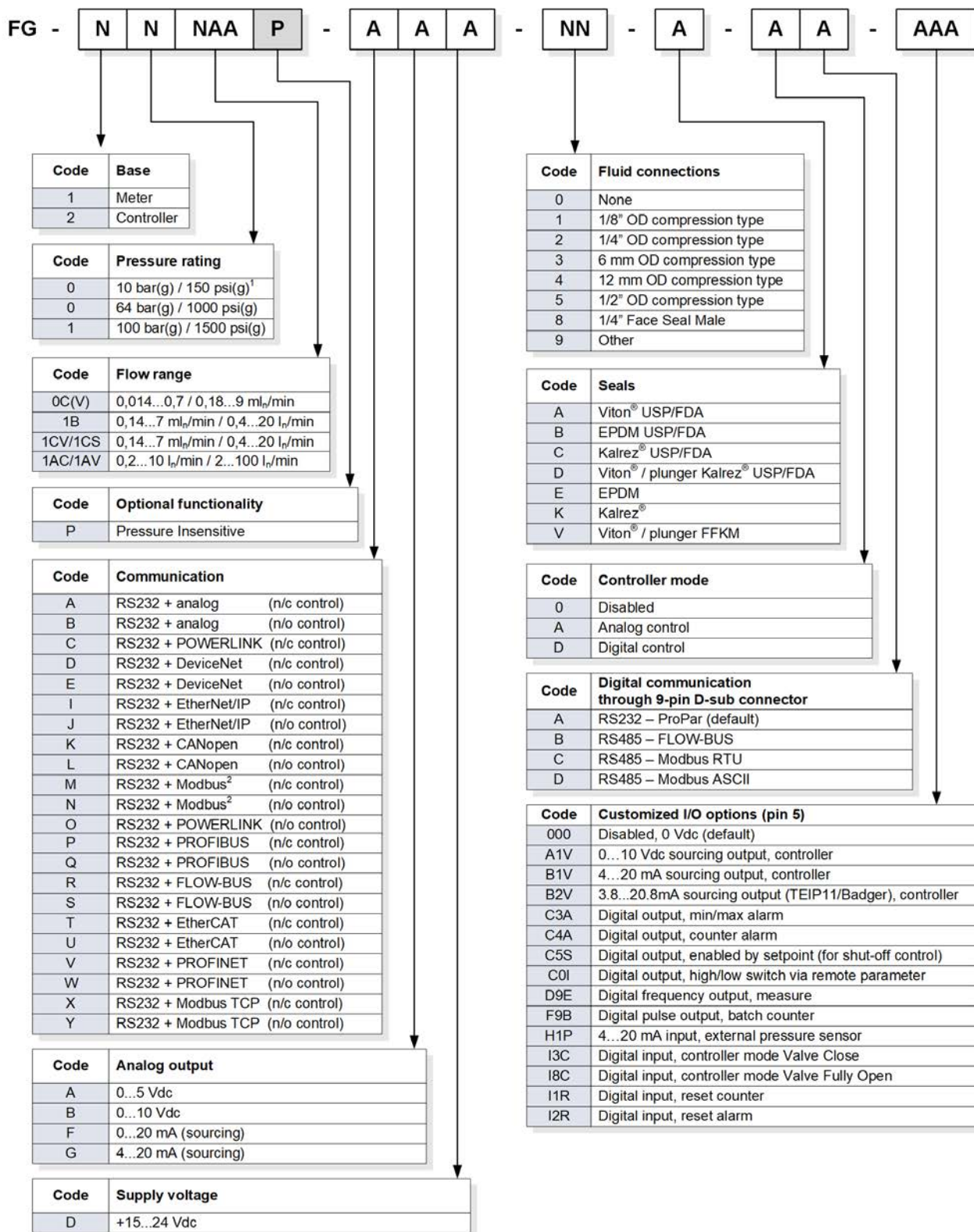

1) for CVP, CS and CSP models

2) default Modbus RTU, optional Modbus ASCII



See section [Customized I/O options \(pin 5\)](#) for more information about the pin-5 configuration options.

## 2 Starting up

### 2.1 Functional properties

Before installing the EL-FLOW® Prestige, check the serial number label on the rear side of the instrument to see if the functional properties match your requirements:

- Flow rate
- Media to be used in the instrument
- Input and output signal (see also section [Electrical connection](#))
- Upstream and downstream pressure(s)
- Operating temperature
- Valve type (NC = Normally Closed, NO = Normally Open)

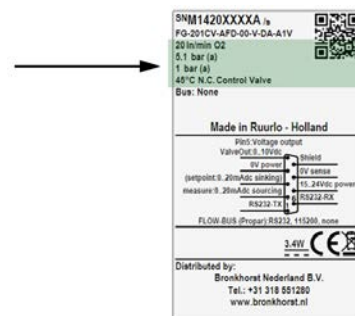

### 2.2 Operating conditions

#### Test pressure



Bronkhorst® instruments are pressure tested to at least 1.5 times the specified operating pressure and outboard leak tested to at least  $2 * 10^{-9}$  mbar l/s Helium.



- The test pressure is stated on a red label on the device; if this label is missing or if the test pressure is insufficient, the device must not be used and should be returned to the factory.
- Before installation, make sure that the pressure rating is within the limits of the normal process conditions and that the tested pressure is in accordance with the safety factor of your application.
- Disassembling and/or replacing fluid system related parts of the device will invalidate the test pressure and leak test specification.

#### Sealing material compatibility



The EL-FLOW® Prestige is fitted with specific sealing material(s), compatible with the media specified at ordering time. See section [Sealing material compatibility](#) for a compatibility list for the most commonly used media.

#### Rapid gas decompression / explosive decompression



For instruments used above 10 barg:  
Bronkhorst recommends a maximum decompression rate of 70 bar/min, according NACE TM0297.  
Exceeding this rate can have negative influence on the lifetime of the sealing materials.

#### Ambient conditions

EL-FLOW® Prestige instruments are suitable for use in conditions between -10 and 70 °C and relative humidity of 10 to 90 % RH, unless specified otherwise. Please note that EL-FLOW® Prestige instruments have an ingress protection of IP-40, implying that the housing and electrical connection do not offer any protection against moist environments.



Make sure that process gases do not condensate in the instrument due to (changing) environmental conditions, condensed process fluids may seriously harm the instrument's functionality! E.g. do not use moist air as process gas at low temperatures.

### 2.3 Mounting



For optimal performance, observe these guidelines:

- Mount the EL-FLOW® Prestige in an upright position, especially if the operating pressure is higher than 10 bar.
- If the instrument is mounted in a position where the flow is directed upwards or downwards, [adjusting the zero point](#) is recommended.
- Avoid installation in close proximity of mechanical vibration and/or heat sources.
- Use the equipment in an environment with a stable ambient pressure and temperature.



For stable fixation, the bottom of the instrument base is fitted with mounting holes. See the dimensional drawing for the exact locations.

## 2.4 Piping requirements

For reliable performance, make sure the fluid stream is uncontaminated. If necessary, use filters to assure a moisture, oil and particle free gas stream (recommended pore size: 5 µm). If back flow can occur, the use of a downstream filter and check valve is also recommended. Select a suitable filter size, to avoid a too high pressure drop.



- Use piping or tubing that is suitable for the operating conditions of the application (media, maximum temperature, maximum operating pressure).
- Do not install small diameter piping/tubing on high flow rates and avoid abrupt angles or other disturbances within a distance of 10 times the (inside) pipe diameter from the inlet or outlet of the device.
- Do not install pressure regulators within a distance of 25 times the (inside) pipe diameter from a controlling instrument.

## 2.5 Fluid connection

- Install the EL-FLOW® Prestige in the process line, in accordance with the direction of the FLOW arrow on the base of the instrument.
- Tighten connections according to the instructions of the supplier of the fittings. The use of Swagelok RS-type stainless steel adapters is recommended.



Check the fluid system for leak tightness after any modification and before applying full operating pressure, especially when using hazardous media (e.g. toxic or flammable).

## 2.6 Electrical connection

Electrical connections must be made with standard cables or according to the applicable hook-up diagram (see section [Documentation](#)). The factory installed 9-pin D-sub settings are indicated on the serial number label. Make sure that the power supply is suitable for the power ratings as indicated on the serial number label, and that double or reinforced insulation is used for the power supply cabling.

EL-FLOW® Prestige instruments are powered with +15...+24 Vdc, depending on the fieldbus system (if applicable).

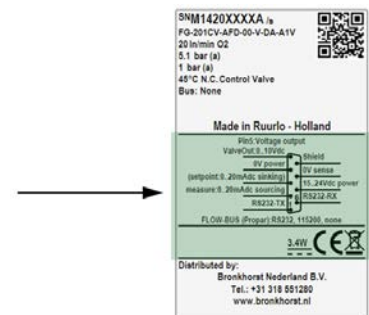

To comply with **IEC61010-1** requirements, limit the circuit current by using a limited-energy power source. A National Electrical Code (**NEC**) **Class 2** power source must be used that complies with **IEC 60950-1** (Limited Energy Circuit). As an alternative, the unit shall be supplied by a power source with reinforced insulation to mains in conjunction with a fuse in accordance with **UL248**. The fuse shall be rated max. 3 A and must be installed in the 15...24 Vdc power supply to the device in order to limit the available current.



Always turn off electrical power before connecting or disconnecting equipment electrically.



**Never** power the instrument simultaneously from **two different power sources** (e.g. fieldbus and Plug-in Power Supply). Doing so will irreversibly damage the printed circuit board and the instrument will have to be repaired before it can be used.



In order to be able to comply with all applicable guidelines and regulations, it is essential that electrical connections be made by or under supervision of a qualified electrician.



- The equipment described in this document contains electronic components that are susceptible to **electrostatic discharge**.
- When working on the electrical installation, take appropriate measures to prevent damage as a result of electrostatic discharge.



The **CE mark** on the equipment indicates that it complies with requirements imposed by the European Union, including **electromagnetic compatibility (EMC)**.

EMC can only be guaranteed by applying appropriate cables and connectors or gland assemblies:

- Cable wire diameters must be sufficient to carry the supply current and minimize voltage loss.
- When connecting the product to other devices, ensure that the integrity of the shielding remains uncompromised; use shielded cables and connectors where possible and/or required.
- Preferably use the supplied cables (if applicable) to make electrical (signal) connections to and between the supplied components. These cables are shielded, have the required wire diameter, and loose ends (if applicable) are marked to facilitate correct connection.

If not all requirements for proper shielding can be met (for example, because a component is not equipped with shielded connectors), take the following measures to ensure the best possible shielding:

- Keep cable lengths at a minimum.
- Route cables as closely as possible alongside metal structures or components.
- Ensure all electrical components are grounded to earth.

When in doubt about the shielding of your cabling and/or electrical connections, contact your Bronkhorst representative.

## 2.7 Analog / digital communication

### 2.7.1 Analog / local communication



If the instrument has a FLOW-BUS, Modbus or DeviceNet™ interface and is configured for digital communication, the 9-pin D-sub connector is protected by a dust cover. To gain access to the analog/local interface, the dust cover can be removed by pushing its lower end.



Use a loose-end cable with a 9-pin D-sub female connector on the instrument side (art. no. 7.03.004, 7.03.536 or 7.03.537) and refer to the hook-up diagram for analog operation to connect the required signals.



### 2.7.2 Digital RS232 communication

Digital operation over RS232 can be established when using the setup shown here or using a Bronkhorst® E-8000 readout/control unit. See section [Basic RS232 operation](#) for more cabling examples. Connecting the instrument with an RS232 cable or an RS232 cable with an RS232 to USB converter to a PC enables the use of the (free) Bronkhorst® FlowWare software for Windows, such as FlowDDE and FlowPlot. Make sure that the serial number label indicates RS232 settings for the 9-pin D-sub connector and apply the proper baud rate settings. If the instrument is not set for RS232 communication, please refer to [Basic RS232 operation](#) for switching to RS232 communication settings via the 'Configuration Mode'.

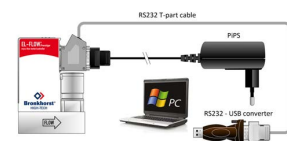



A PiPS (Plug-in Power Supply, article no. 7.03.422) is available to power a single instrument and can be used instead of the DB9 loose-end cable, as shown in the example above. Detailed information can be found in the **PiPS manual** (document no. 9.17.055) which can be downloaded from the **Accessories and software** section on the Bronkhorst® product pages ([www.bronkhorst.com/products](http://www.bronkhorst.com/products))

### 2.7.3 Digital RS485 / fieldbus communication

With digital operation over RS485 or Ethernet a bus system with multiple instruments can be set up:

- For RS485 FLOW-BUS or Modbus operation over the 9-pin D-sub connector or via an additional fieldbus driver (if installed), see section [Basic RS485 operation \(FLOW-BUS/Modbus\)](#).
- For operation via other additional fieldbus systems (e.g. DeviceNet™, EtherCAT®), refer to section [Other fieldbus configurations](#) or the specific fieldbus manual.

## 2.8 Micro switch operation

Using the two colored LEDs and the micro switch on the **EL-FLOW® Prestige**, several actions can be monitored and started. The green LED is used for status indication. The red LED is used for errors, warnings and messages. The switch can be used to start several actions, such as auto-zero, restoring factory settings and bus initialization actions, if applicable.



- See section [Adjusting zero point](#) for background information about and instructions for zeroing.
- See section [Micro switch functions](#) for a comprehensive description of the micro switch functionality.



The micro switch on top of the **EL-FLOW® Prestige** can be operated with a thin, metal or hard plastic pin, e.g. the end of a paperclip.

## 2.9 Powering up and powering down



To maintain control of the fluid system and ensure a safe situation, it is recommended to turn on power before applying fluid pressure and to switch off power only after the fluid system is depressurized.



When pressurizing, prevent pressure shocks by gradually bringing the fluid system to the required operating pressure.



For best performance, allow the device to warm up and stabilize for at least 30 minutes before starting measurement and/or control. This may be done with or without media flow.



After powering up, the control valve will act according the last known setpoint. When setpoint is 0, this means the valve closes (normally open) or stays closed (normally closed). The valve stays closed until the instrument receives a new valid setpoint from the active setpoint source.

## 2.10 First use



In systems for use with corrosive or reactive media, purging for at least 30 minutes with a dry, inert gas (like Nitrogen or Argon) is absolutely necessary before use. After use with corrosive, reactive or hazardous media (e.g. toxic or flammable), purging is also necessary before the fluid system is exposed to air.



The very first time the instrument is used, adjusting the zero point is recommended. See [Adjusting zero point](#) for background information and instructions.

## 2.11 Calibration

The EL-FLOW® Prestige has been factory calibrated. Periodical inspection, recalibration or verification of the accuracy may be subject to individual requirements of the user. Whenever necessary, contact your Bronkhorst representative for information and/or making arrangements for recalibration.

Bronkhorst certifies that the instrument meets the rated accuracy. Calibration has been performed using measurement standards traceable to the Dutch Metrology Institute (VSL).



Note that the calibration only applies to the primary measurement/control function of the instrument; secondary outputs (like temperature and pressure) are outside the calibration scope.

## 2.12 Maintenance



*Inexpertly servicing instruments can lead to serious personal injury and/or damage to the instrument or the system it is used in. Servicing must therefore be performed by trained and qualified personnel. Contact your Bronkhorst representative for information about cleaning and calibration. Bronkhorst has trained staff available.*

- The EL-FLOW® Prestige needs no regular maintenance if operated properly, with clean media, compatible with the wetted materials, avoiding pressure and thermal shocks and vibrations.
- The instrument's fluid path (the wetted parts) may be purged with a clean, dry and inert gas.
- In case of severe contamination, cleaning the wetted parts may be necessary. This requires the instrument to be returned to the factory.



## 3 Basic operation

### 3.1 Mass flow measurement and control

After correct installation of the **EL-FLOW® Prestige** Mass Flow Meter (MFM) or Mass Flow Controller (MFC) and when all safety precautions have been taken into account the instrument can immediately be used for measuring/ controlling the required flow rate in the system by means of the selected communication interface(s).

Here are some general guidelines for mass flow measurement/control:



**EL-FLOW® Prestige** MFMs/MFCs are most accurate at the specified inlet/outlet pressure, temperature and process gas conditions, however the instrument will function properly in a wide range of varying conditions. It is strongly advised to use the FlowTune™ software available with the instrument to set the correct process conditions if the actual process conditions differ from the conditions for which the instrument is set (see further).

Although **EL-FLOW® Prestige** MFMs/MFCs have excellent temperature stability, the best accuracy is achieved when temperature differences across the instruments are avoided; make sure that the gas temperature equals the ambient temperature and mount the instruments on a rigid (heat conducting) surface.

Regular **EL-FLOW® Prestige** MFCs handle pressure shocks in the system well, but are not insensitive to pressure fluctuations. For optimum control stability, provide a stable (pressure controlled) inlet pressure with sufficient buffer volume between the pressure regulator and the MFC and avoid installing multiple MFCs or other control valves in close proximity to another with small volume piping in between.

**EL-FLOW® Prestige PI** instruments (see [EL-FLOW® Prestige PI](#)) and instruments with **I/O option H1P** enabled (see [Customized I/O options \(pin 5\)](#)) automatically and continuously adjust the flow rate, based on the actual pressure measured by the built-in or external pressure sensor respectively.

When an MFC (either with normally closed (NC) or normally open (NO) valve) is hooked-up, the control valve stays closed when no setpoint is given. When the MFC receives a setpoint from the active setpoint source, the internal PID controller will immediately open the control valve until the required flow rate is achieved and it will maintain that flow rate until another setpoint is given.

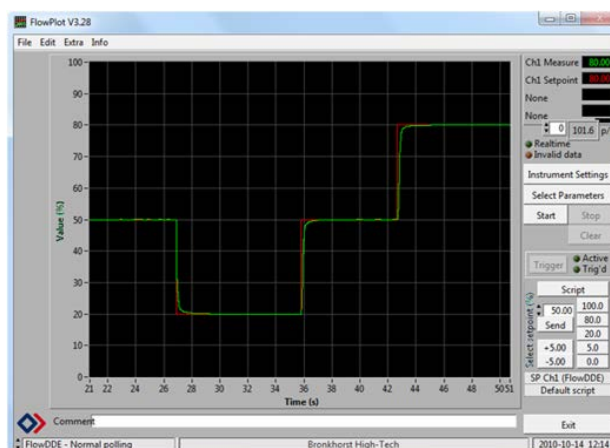

#### 3.1.1 Changing fluid set, range or operating conditions

EL-FLOW® Prestige instruments provide Multi Fluid/Multi Range functionality (MFMR). With this functionality, the properties of a selection of 100 pre-installed gases or any mixture thereof can be used to reconfigure the instrument.

MFMR enabled instruments are calibrated ex factory for a number of standard measuring ranges, which can be configured for use with different fluids. Defining fluids and ranges and selecting the active fluid can be done via RS-232 with FlowTune™.

FlowTune™ provides the following key functionality:

- Definition and storage of up to eight different fluids in the instrument
- Storing fluid properties for any gas
- Changing upstream- and/or downstream pressure based on actual process conditions
- Re-ranging the full scale (FS) flow rate within the instrument's supported flow range
- Changing control speed per fluid set for faster or slower (smoother) flow control

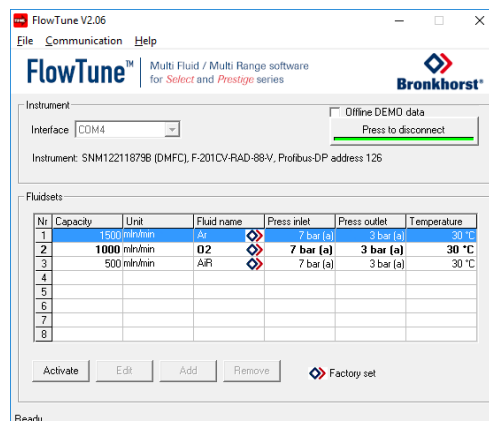

MFMR functionality is available for the full temperature and pressure range of the instrument. FlowTune™ checks the changes for the following limitations:

- Rangeability of the flow sensor for the selected fluid
- Rangeability of the control valve for the selected fluid
- Accuracy indication for the given flow range
- Compatibility of selected gases with the used sealing materials (see [Sealing material compatibility](#))
- Limitations to the operating conditions

After all limitation checks are passed, the entered properties are stored in the instrument, including the required controller settings. When switching to another fluid set, controller settings are automatically adjusted to the new process conditions, so there is no need to change PID controller settings manually.



The FlowTune™ software and the associated documentation can be downloaded from the product pages on the Bronkhorst website: [www.bronkhorst.com/products](http://www.bronkhorst.com/products)



**Note regarding instruments with active pressure compensation:**

For **EL-FLOW® Prestige PI** (see [EL-FLOW® Prestige PI](#)) instruments and instruments with **I/O option H1P** enabled (see [Customized I/O options \(pin 5\)](#)) the inlet pressure entered in FlowTune is used only for flow range/capacity calculations (see [Advanced fluid set parameters](#)).



To connect with FlowTune™, use RS232 communication via the 9-pin D-sub connector. In case a connection cannot be established, use the power-up functionality of the [multifunctional switch](#) to switch to configuration mode and enable RS232 communication.

After configuring the required parameters, remember to return the instrument to the original communication mode.

It is advised to use FlowTune™ only in a non-operational environment. FlowTune™ will force the instrument to [Valve Safe State](#) as soon as the connection is made. Be sure to close communication between FlowTune™ and the instrument properly, to restore the normal operating mode.

**Using custom fluids or fluid properties**

With FlowTune™ fixed fluid properties for any gas or mixture can be stored in the instrument (density, heat capacity, thermal conductivity and dynamic viscosity). Although custom fluid data can be used, Bronkhorst advises to use the FLUIDAT® on the Net website for calculation of fluid properties at the actual process conditions. FLUIDAT® is a collection of routines to calculate physical properties of gases and liquids. These routines are made available at the FLUIDAT® on the Net website.



FLUIDAT® on the Net can be accessed on [www.fluidat.com](http://www.fluidat.com). You can try out FLUIDAT® on the Net with a limited number of fluids. Free registration on the FLUIDAT® website gives access to all available fluids and functionality.

### 3.1.2 Valve Safe State

When a controlling instrument is not powered or cannot communicate with the fieldbus network (if applicable), all electrical valves operated by the instrument (whether integrated or external) automatically return to their default state. The default state is closed for 'normally closed' valves (n/c) and fully open for 'normally open' valves (n/o).

Check the serial number label or the [technical specifications](#) to see which valve type is used on your instrument (if applicable).

## 3.2 Communication interfaces

Numerous input/output options can be installed on **EL-FLOW® Prestige** instruments via both the 9-pin D-sub connector on the side of the instrument and the optional fieldbus connector on top of the instrument.

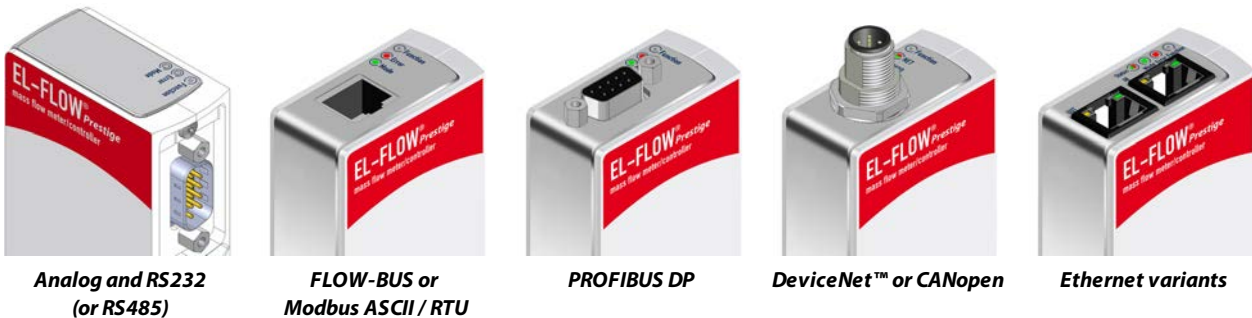

The standard 9-pin D-sub connector provides the following communication interfaces:

- Analog (0...5 Vdc; 0...10 Vdc; 0...20 mA or 4...20 mA)
- Digital RS-232 ([ProPar](#)) or RS-485 (FLOW-BUS or Modbus)

Additionally, the instrument can be provided with one of the following optional digital fieldbus interfaces:

- CANopen
- DeviceNet™
- EtherCAT®
- EtherNet/IP
- FLOW-BUS
- Modbus (ASCII / RTU / TCP)
- POWERLINK
- PROFIBUS DP
- PROFINET

The default communication protocol of the instrument (analog, digital RS-232 or fieldbus) is specified at ordering time.

### 3.2.1 Using multiple interfaces

The analog interface is always present on **EL-FLOW® Prestige** instruments. An interface to any available field bus is optional. Operation via analog interface, RS232/RS485 (side connector) and an optional fieldbus (top connector) can be performed at the same time. When using multiple interfaces, reading of parameters can be done simultaneously. When changing a parameter value, the last value sent by any of the interfaces will be valid.

#### Control mode

A controller setpoint is accepted from either the analog or digital interface, but not both. Analog or digital operation is selected at ordering time and is indicated on the serial number label. The inactive setpoint source is indicated between brackets (see example below). The parameter *Control Mode* indicates from which source a controller setpoint is accepted: analog or digital. See section [Special parameters](#) for more information regarding the *Control Mode* parameter.

#### Factory communication settings

The factory selected communication and side connector pinning settings are indicated on the serial number label. See example below for a description of the communication information:

1. [Model key](#)
2. Fieldbus (top connector) (example: none)
3. [Customized I/O setting \(pin 5\)](#)
4. Analog interface (pin 2, 3) (example: inactive setpoint source, measure always available)
5. Digital interface (pin 1, 6) (example: RS232, active setpoint source)
6. Side connector digital interface settings (protocol, medium, baud rate, parity) (example: FLOW-BUS (ProPar) communication over RS232 interface with baud rate 115200 Baud and no parity)

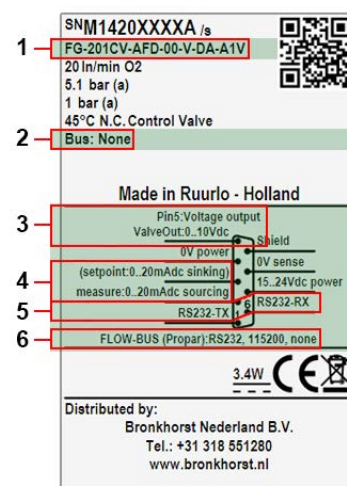

### 3.3 Analog operation

The following analog signals are available for each instrument through the 9-pin D-sub side connector:

- Measured value (analog output): pin 2
- Setpoint (analog input/setpoint): pin 3

The factory selected analog interface (0...5 Vdc; 0...10 Vdc; 0...20 mA or 4...20 mA) can be found in the [model key](#) of the instrument and in the pin description on the serial number label.

Pin 5 is used for customized I/O configurations. By default it is disabled and pulled down to 0 Vdc. The factory selected pin 5 configuration can be found in the [model key](#) and the pin description on the serial number label. See also section [Customized I/O options \(pin 5\)](#).



When operating the instrument through the analog interface it is possible to connect the instrument simultaneously to RS232 for reading/changing parameters (e.g. settings or fluid selection).

#### 3.3.1 Cabling

Use a loose-end cable with a 9-pin D-sub female connector on the instrument side (art. no. 7.03.004, 7.03.536 or 7.03.537) and refer to the hook-up diagram for analog operation to connect the required signals.



### 3.4 Basic RS232 operation

Digital RS232 (or bus) operation adds a lot of extra features to the instruments compared to analog operation, such as:

- Multi gas / multi range functionality; up to eight selectable and customizable fluids ([Fluid set](#))
- Direct reading with a readout/control module or host computer
- Device identification and diagnostics ([Device identification](#))
- Adjustable minimum and maximum alarm limits ([Alarms](#))
- (Batch) counter ([Counter](#))

Each instrument process is controlled (internally) by specific parameters. The instrument parameter values are accessible through the available digital interfaces to influence the instrument behavior. In this section it is explained how to operate an instrument using RS232 communication.



Make sure that the serial number label indicates RS232 settings for the 9-pin D-sub connector and apply the proper Baud rate settings. If the instrument is not set for RS232 communication, use the micro switch on top of the instrument to overrule the custom settings and switch to RS232 communication settings: press and hold the micro switch at power-up and wait (12... 16 sec) until both ● green and ● red LEDs flash (0.2 sec on, 0.2 sec off). Release the switch to activate the 'Configuration Mode'. In the 'Configuration Mode' the bus type and baud rate for the 9-pin D-sub side connector are set to RS232 FLOW-BUS (ProPar) at 38400 Baud. The 'Configuration Mode' remains active after power down. Use the same procedure to deactivate the 'Configuration Mode'.

### 3.4.1 Cabling

#### 3.4.1.1 RS232 communication

Using a Windows computer, the instrument can be monitored and operated via RS-232. For operation, the free Bronkhorst FlowWare tools can be used, providing a comprehensive user interface to the digital instrument functions.

This example uses the following components:

- EL-FLOW® Prestige
- RS-232 T-part cable (art no. 7.03.366)
- RS-232 to USB converter (art no. 9.09.122)
- Windows computer (for readout and control)
- Plug-in Power Supply (PiPS, art no. 7.03.422)

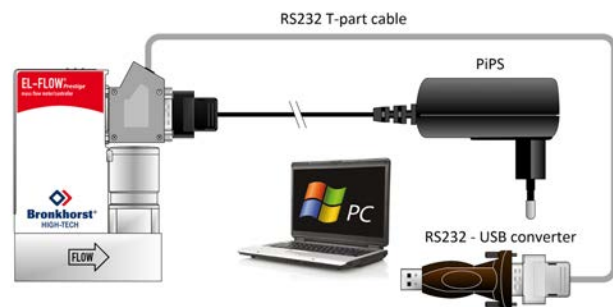

Connect the T-part cable with the 9-pin D-sub connector on the side of the instrument and use the RS-232/USB converter to connect the other end of the cable with a free USB port of the computer.



For communication with a **PLC or other** controlling device, a 9-pin D-sub cable with a loose end (part no. 7.03.004, 7.03.536 or 7.03.537) can be used. Consult the [RS-232 hook-up diagram](#) for wiring details.



For RS-232 communication at baud rates up to 38400 Baud the maximum allowable cable length is 10 m. For higher baud rates, use a maximum cable length of 3 m.



- For more information about communication through the RS-232 interface, consult the [RS-232 manual](#).
- The FlowWare tools and associated documentation can be downloaded from the **Accessories and software** section on the Bronkhorst® product pages ([www.bronkhorst.com/products](http://www.bronkhorst.com/products)).

### 3.4.1.2 RS232 communication powered by fieldbus

The instrument can be connected to a fieldbus system with the optional fieldbus connector on top. At the same time, RS-232 communication with a Windows computer is possible through the 9-pin D-sub connector on the side of the instrument.

This example uses the following components:

- EL-FLOW® Prestige with DeviceNet™ interface
- DeviceNet™ M12 cable (art no. 7.03.323)
- DeviceNet™ M12 Y adapter (art no. 7.03.319)
- RS-232 cable (art no. 7.03.367)
- RS-232 to USB converter (art no. 9.09.122)
- Windows computer (for readout and control)

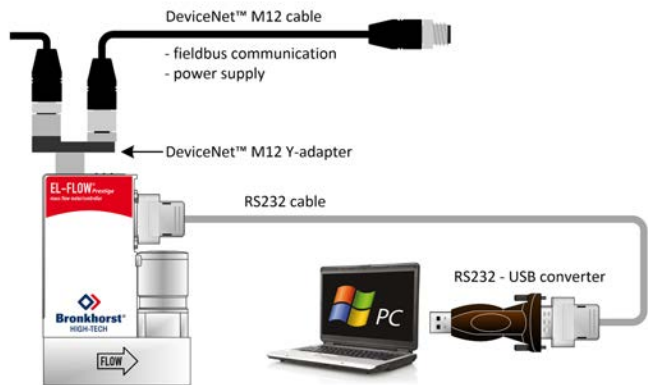

Note that the used fieldbus components in this example are specific to DeviceNet™. For connecting with other fieldbus systems, other cables and adapters are needed.



Always check the total power consumption of your instruments before connecting them to a fieldbus system. Do not exceed the maximum power of the power supply unit.



For all available fieldbus types except PROFIBUS DP, the fieldbus connection on is used to power and operate the instrument. For PROFIBUS DP, the instrument needs to be powered through the 9-pin D-sub connector on the side of the instrument as shown in [RS232 communication](#).



For information about setting up a fieldbus network with Bronkhorst® instruments, consult the according [fieldbus manual](#). If you need assistance with setting up a fieldbus system, contact your Bronkhorst representative for information.

### 3.4.1.3 E-8000 power supply, readout and control

Using an E-8000 module, instruments can be powered (100...240 Vac) and operated via RS-232. Most digital parameters and functions are accessible via the display interface and the control buttons.

This example uses the following components:

- 2x EL-FLOW® Prestige
- 2x RS-232/power supply cable (art no. 7.03.016/7.03.538/7.03.539)
- E-8000 power supply, readout and control module

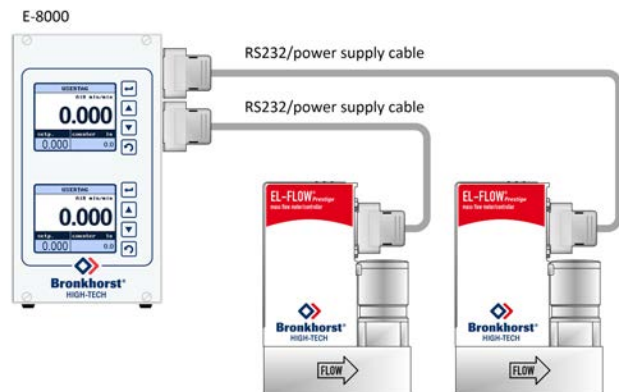

Consult the **E-8000 manual** (document 9.17.076) for more information. This manual can be downloaded from the **Accessories and software** section on the Bronkhorst® product pages ([www.bronkhorst.com/products](http://www.bronkhorst.com/products)).

### 3.4.1.4 BRIGHT readout and control

Most digital parameters and functions are accessible via the display interface and control buttons of a BRIGHT readout and control module (type B1 or B2). When a BRIGHT module is installed, no other RS-232 connection can be established with the instrument.

This example uses the following components:

- EL-FLOW® Prestige
- BRIGHT readout and control module
- Plug-in Power Supply (PIPS, art no. 7.03.422)



Use the 9-pin D-sub connector on the side of the instrument to plug in the T-part that comes with the BRIGHT module.



Consult the **BRIGHT manual** (document 9.17.048) for more information. This manual can be downloaded from the **Accessories and software** section on the Bronkhorst® product pages ([www.bronkhorst.com/products](http://www.bronkhorst.com/products)).

### 3.4.2 FlowDDE

Digital Bronkhorst® instruments can be operated via RS-232 using the Bronkhorst® FlowDDE server application. Dynamic Data Exchange (DDE) provides a basic level of inter process communication between Windows applications. Together with a client application, either self-made or with a third party SCADA program, it is possible to create an easy way of data exchange between the flow meter/controller and a Windows application. For instance, a cell in a Microsoft Excel spreadsheet can be linked to the measured value of an instrument; FlowDDE updates the cell automatically when the measured value changes.

FlowDDE uses specific parameter numbers for communicating with the instrument. A DDE parameter number is a unique number in a special FlowDDE instruments/parameter database and not the same as the parameter number from the process on an instrument. FlowDDE translates the node-address and process number to a channel number.

DDE-client applications communicate with the FlowDDE server by using DDE messages. Before messages can be exchanged, a DDE link has to be made. A DDE link consists of three parts: the server, the topic and an item. For separation the characters '|' and '!' may be used, so a DDE link in e.g. Microsoft Excel becomes: Server|Topic|Item.

For standard instrument parameters and the FlowDDE server, these are:

- Server: FlowDDE or FlowDDE2
- Topic: 'C(X)' for channel number X
- Item: 'P(Y)' for parameter number Y

An example of a DDE link in a Microsoft Excel cell is =FlowDDE|C(1)!P(8) to read parameter 8 of channel 1.

When not using FlowDDE for communication with the instrument, parameters are addressed by:

- Node address
- Process number
- Parameter number

See section [Basic parameters and properties](#) for more information about instrument parameters.

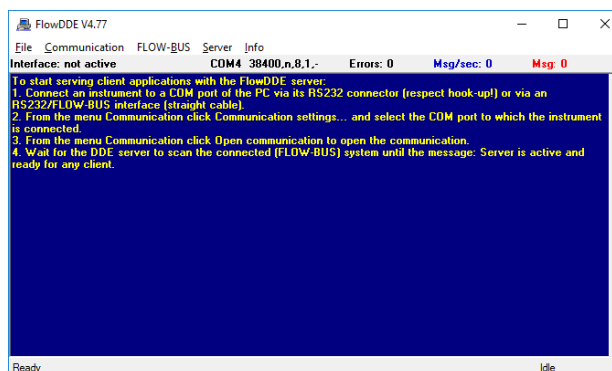

For more information about FlowDDE, including setting up a DDE link, consult the **FlowDDE Manual** (document no. 9.17.067) or the help file in the application.

### 3.4.3 Software (DDE applications)

Examples of free Bronkhorst® DDE client applications: FlowPlot and FlowView. Other software programs supporting DDE are for example MS-Office, LabVIEW, InTouch and Wizcon.

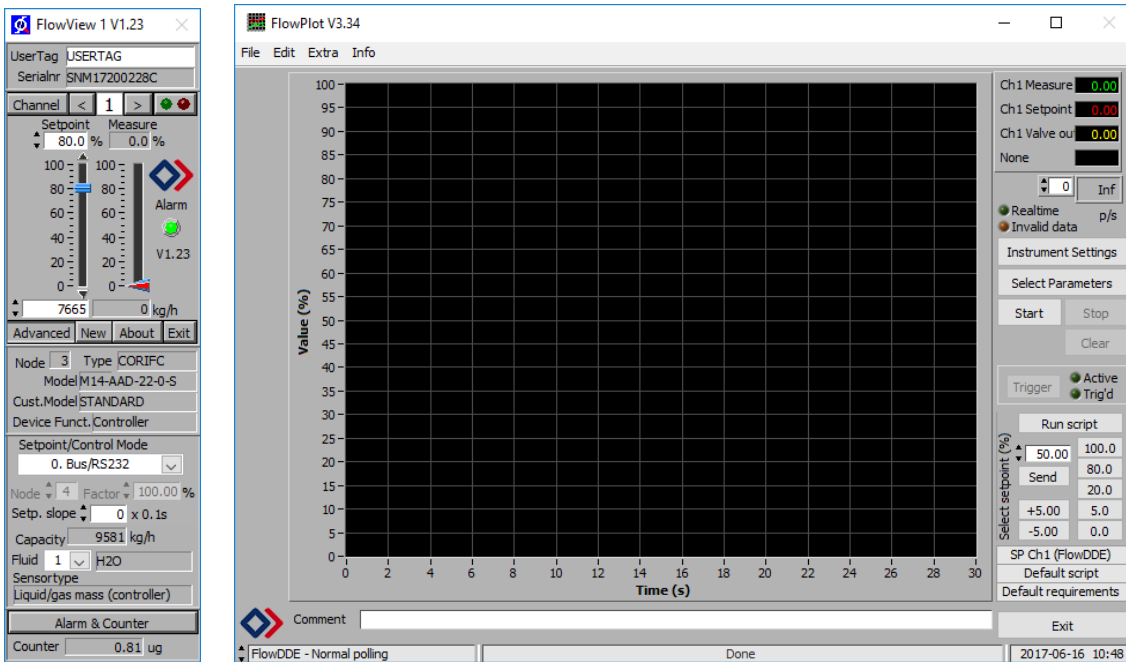

Bronkhorst® software applications 'FlowView' (left) and 'FlowPlot' (right)



FlowDDE and other Bronkhorst® applications are available on the support CD or can be downloaded from the product pages on the Bronkhorst website: [www.bronkhorst.com/products](http://www.bronkhorst.com/products)

### 3.4.4 Baud rate setup

EL-FLOW® Prestige instruments support the following baud rates for RS232 communication. The factory selected baud rate is indicated on the serial number label. See section [Network configuration](#) for changing the baud rate settings for the instrument. The default baud rate for RS232 communication is 38400 Baud.

<b>Mode:</b>	<b>Digital</b>
<b>Interface/medium:</b>	<b>RS232</b>
<b>Protocol:</b>	<b>FLOW-BUS (ProPar)</b>
<b>Baud rate:</b>	9600 16200 <b>38400</b> 57600 115200 230400 460800
<b>Node address:</b>	<b>3</b>
<b>Parity:</b>	<b>None</b>



Make sure that the instrument's baud rate corresponds with the baud rate of the application the instrument is communicating with, otherwise no communication can be established.

For RS232 communication, the maximum cable length is 10 m for baud rates up to 38400 Baud. For higher baud rates, use cable lengths of maximum 3 m.



For more information regarding communication through an RS232 interface, see **document 9.17.027: RS232 interface with FLOW-BUS for digital instruments.**



### 3.5 Basic RS485 operation (FLOW-BUS/Modbus)

This section is limited to RS485 FLOW-BUS or Modbus communication. See section [Other fieldbus configurations](#) for communication through other fieldbus interfaces.

FLOW-BUS or Modbus communication is available if either the FLOW-BUS or Modbus RJ-45 connector on top of the instrument is present, or if the 9-pin D-sub side connector is set for FLOW-BUS or Modbus communication. The serial number label indicates the factory settings of the connector pinning.

#### FLOW-BUS

FLOW-BUS is a Bronkhorst® designed fieldbus, based on RS-485 technology, for digital communication between devices, offering the possibility of host-control by a Windows computer.

Characteristics:

- Baud rate 187500 (default) or 400000 Baud
- +15...24 Vdc supply voltage
- Easy installation and communication with other Bronkhorst® devices
- Automatic node search and bus optimization (gap fixing)
- RS-232 communication ([ProPar](#)) with Windows computer (local host)
- Connection of up to 120 instruments on a single bus
- Maximum bus length: 600 m



Consult **Instruction manual FLOW-BUS interface** (document no. 9.17.024) for more information about setting up a FLOW-BUS network.

#### Modbus

Modbus is a 3-wire, RS-485-based fieldbus communication system for parameter value exchange. In this system each instrument/device is equipped with a micro-controller for its own dedicated task. The instrument behaves as a slave, which means all communication (instructions and readout) is initiated by a master device on the Modbus system.

Characteristics:

- Baud rate selectable between 9600 and 256000 Baud (default: 19200 Baud)
- +15...24 Vdc supply voltage
- Connection of up to 247 instruments on a single bus
- Supports RTU and ASCII protocols



Consult **Instruction manual Modbus interface** (document no. 9.17.035) for more information about setting up a Modbus network.



More detailed information about Modbus can be found at [www.modbus.org](http://www.modbus.org) or any website of the (local) Modbus organization of your country (if available).

### 3.5.1 Cabling

This section shows cabling examples of some **EL-FLOW® Prestige** instruments in an RS485 fieldbus system. Note that many other fieldbus configurations are possible, contact your local sales representative for more information. Please check the total power consumption of your instruments and do not exceed the maximum power of the power supply.

#### FLOW-BUS setup

In the example below an E-8000 power supply/readout control unit with FLOW-BUS is connected to two **EL-FLOW® Prestige** instruments via the RJ-45 top-connector FLOW-BUS interface. In this example one instrument serves as a local host for RS232 communication with a Windows computer through the 9-pin D-sub connector on the side of the instrument. All other instruments on the FLOW-BUS network are also accessible via the local host. It is even possible to use multiple local host RS232/FLOW-BUS interfaces simultaneously.

The following components are used in this example:

- 2x EL-FLOW® Prestige
- 2x modular Y adapter cable (art. no. 7.03.241)
- 2x RJ-45 patch cable (art.no 7.03.238)
- RJ-45 begin terminator (art. no. 7.03.297)
- RJ-45 end terminator (art. no. 7.03.298)
- E-8000 power supply, readout and control module
- RS232 cable (art.no. 7.03.367)
- RS232-USB converter (art no. 9.09.122)
- Windows computer

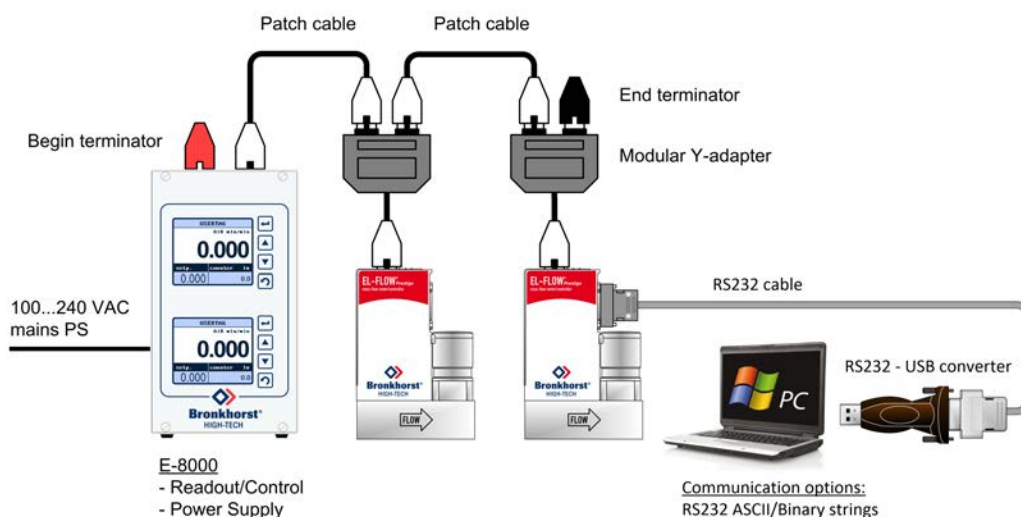

Power the instruments in a FLOW-BUS local-host system by hooking-up the power supply directly on the FLOW-BUS line and not by powering instruments through the 9-pin D-sub connector.

### Modbus setup

In the example below the Modbus power supply is provided by an E-8000 module. The **EL-FLOW® Prestige** instruments are connected to the fieldbus network via RS485 cables with RJ-45 connector and a multiport connector. The RS485 - USB2.0 adapter can be used to connect the system to a Modbus master device.

The following components are used in this example:

- 3x EL-FLOW® Prestige
- 2x modular Y adapter cable (art. no. 7.03.241)
- 3x RJ-45 patch cable (art.no 7.03.238)
- RJ-45 begin terminator (art. no. 7.03.297)
- RJ-45 end terminator (art. no. 7.03.298)
- RJ-45 multiport connector (art. no. 7.03.299)
- E-8000 power supply module
- RS485 - USB2.0 adapter (art. no. 7.03.470)

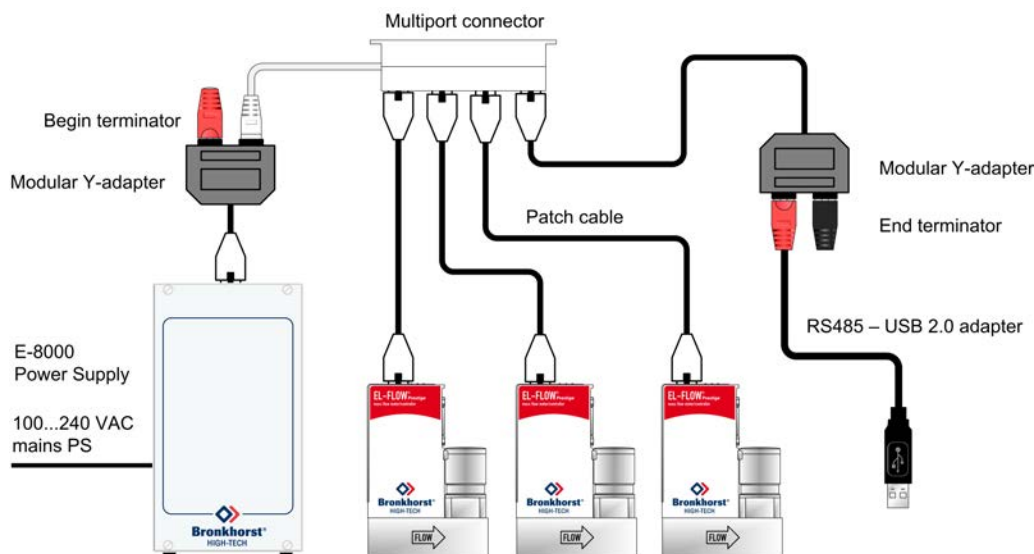

For supported power supply and communication options, refer to the **E-8000 manual** (document no. 9.17.076)

### 3.5.2 Software

When using a Windows computer to communicate with **EL-FLOW® Prestige** instruments, only the ProPar protocol (used by FLOW-BUS) is supported by Bronkhorst® software. When using Modbus operation, software from third parties, such as LabVIEW, ModScan or a Modbus PLC must be used to serve as Modbus master.



*Note: an instrument with 9-pin D-sub side connector set for RS485 FLOW-BUS or Modbus communication will not respond when connecting to an RS232 configuration. If the instrument is not set for RS232 communication, use the micro switch on top of the instrument to override the custom settings and switch to RS232 communication settings: press and hold the micro switch at power-up and wait (12... 16 sec) until both **green** and **red** LEDs flash (0.2 sec on, 0.2 sec off). Release the switch to activate the 'Configuration Mode'. In the 'Configuration Mode' the bus type and baud rate for the 9-pin D-sub side connector are set to RS232 FLOW-BUS (ProPar) at 38400 Baud. The 'Configuration Mode' remains active after power down. Use the same procedure to deactivate the 'Configuration Mode'.*

### 3.5.3 Baud rate, node address and parity setup

**EL-FLOW® Prestige** instruments are configured from factory as indicated on the serial number label. If there is a need of changing any of the specified RS485 settings, see the tables below for the supported configurations. The default selections are printed in boldface.

Mode:	Digital		
Interface/medium:	RS485		
Protocol:	FLOW-BUS	Modbus RTU	Modbus ASCII
Baud rate:	187500 400000	9600 <b>19200</b> 38400 56000 57600 115200 128000 256000	9600 <b>19200</b> 38400 56000 57600 115200 128000 256000
Node address:	3...125	1...247	1...247
Parity:	None	None; <b>Even</b> ; Odd	None; <b>Even</b> ; Odd

#### Changing RS485 settings of the RJ-45 top connector interface

In case the FLOW-BUS or Modbus RJ-45 field bus connector is used for bus communication, the node address can be easily set by using the rotary switches on the side of the instrument. Use the 'MSD' (Most Significant Digit) to set the 'tens' of the bus-address and the 'LSD' (least Significant Digit) to set the 'unit' of the bus-address (the example on the right reads '63'). Set the rotary switches to '00' for automatic installation. Refer to the corresponding field bus manual, **document 9.17.024** (FLOW-BUS) or **document 9.17.035** (Modbus) for more details.

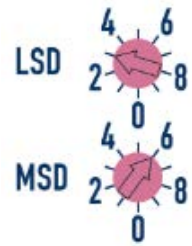

For changing the baud rate or parity settings use the RS232 interface to change the corresponding parameters (see section [Network configuration](#)).

#### Changing RS485 settings of the 9-pin D-sub side connector interface

In case the 9-pin D-sub side connector is set for RS485 communication, the baud rate or node address can be changed by using the micro switch or by changing the settings in the 'Configuration Mode'. Refer to **section 3.8** for changing node address and baud rate with the micro switch. Other communication parameters can be changed only in the 'Configuration Mode'. Activate the 'Configuration Mode' by pressing the micro switch at start-up according to the description in the previous. In 'Configuration Mode' the bus type and baud rate are set to RS232 FLOW-BUS (ProPar) at 38400 Baud. Change the appropriate parameters as described in [Network configuration](#). When finished, deactivate the 'Configuration Mode' using the same procedure. Now the instrument is ready to use in the desired configuration with the adjusted baud rate, node address or parity.



Any changes made to the instrument communication settings will **not** be restored after a factory reset.

## 3.6 Other fieldbus configurations

The following fieldbuses are optionally available for the **EL-FLOW® Prestige** instruments. For all mentioned fieldbus systems the **EL-FLOW® Prestige** instruments serve as slaves on the master/slave bus system. There is no mutual communication between slaves, only between master and slave.

#### PROFIBUS DP

PROFIBUS DP is a 2-wire, RS-485-based industrial data communication standard (fieldbus) which allows automation components (e.g. sensors, actuators and controllers) to exchange information.



Consult **Instruction manual PROFIBUS DP interface** (document no. 9.17.025) for more information about setting up a PROFIBUS DP network.

#### DeviceNet™

The DeviceNet™ interface offers a direct connection to a DeviceNet™ network, according to the mass flow controller profile specified by the ODVA. The Bronkhorst® DeviceNet™ instrument is a Group 2 Only Server device whose messages comply with the Controlled Area Network (CAN) 2.0A standard and with the DeviceNet™ protocol.



Consult **Instruction manual DeviceNet™ interface** (document no. 9.17.026) for more information about setting up a DeviceNet™ network.

**EtherCAT®**

Ethernet for Control Automation Technology (EtherCAT®) is an open high performance Ethernet based fieldbus system.



Consult **Instruction manual EtherCAT® interface** (document no. 9.17.063) for more information about setting up an EtherCAT® network.

**PROFINET**

The PROFINET interface is 100% Ethernet compatible and is used for data exchange between I/O controllers (PLC, etc.) and I/O devices (slaves, field devices). PROFINET uses the proven communication model and application view of PROFIBUS DP.



Consult **Instruction manual PROFINET interface** (document no. 9.17.095) for more information about setting up a PROFINET network.

**3.6.1 Baud rate, node address and parity setup**

In the table below for the supported configurations for PROFIBUS DP, DeviceNet™, EtherCAT® and PROFINET are shown. The default selections are printed in boldface.

Mode:	Digital			
	9-pin D-sub (female)	5-pin M12 (male)	2x RJ45 (in/out)	2x RJ45
Connector:	<b>RS485</b>	<b>RS485</b>	<b>Ethernet</b>	<b>Ethernet</b>
Interface/medium:	<b>PROFIBUS DP</b>	<b>DeviceNet™</b>	<b>EtherCAT®</b>	<b>PROFINET</b>
Protocol:	<b>Autodetect</b> (9600) (19200) (45450) (93750) (187500) (500000) (1500000) (3000000) (6000000) (12000000)	<b>125000</b> 250000 500000	<b>100000000</b>	<b>100000000</b>
Baud rate:	0...126	0..63	0 (n/a)	0 (n/a)
Node address:	Even	None	None	None
Parity:				

**Changing PROFIBUS DP node address**

The node address can be easily set by using the rotary switches on the side of the instrument. Use the 'MSD' (Most Significant Digit) to set the 'tens' of the bus-address and the 'LSD' (least Significant Digit) to set the 'unit' of the bus-address.

**Changing DeviceNet™ node address and data rate**

The node address and data rate can be easily set by using the rotary switches on the side of the instrument. Use the 'MSD' (Most Significant Digit) to set the 'tens' of the bus-address and the 'LSD' (least Significant Digit) to set the 'unit' of the bus-address. Set the 'MSD' rotary switch to 'P' to select programmable bus-address. For the data rate setting select '1' for 125000 Baud, '2' for 250000 Baud, '5' for 500000 Baud and 'P' for programmable data rate.

**Changing EtherCAT® Second Address**

EtherCAT® supports the use of a Second Address. Bronkhorst® instruments have 3 rotary switches, with which a Second Address can be set in the range of 0 – 4095 (0xFFF). This value of the rotary switches will be copied to the Configured Station Alias register (address 0x0012:0x0013) at instrument start-up.

**3.7 LED indications**

The following LED indicators are present on top of the instrument:

- **'Mode'** LED: green ● used for operation mode indication
- **'Error'** LED: red ● used for error/warning messages
- **'NET'** LED: green/red ●/● used for Network status (*DeviceNet™ only*)
- **'MOD'** LED: green/red ●/● used for Module status (*DeviceNet™ only*)
- **'Status'** LED: green/red ●/● used for status indication (*EtherCAT® and PROFINET only*)

### Ethernet indicators

On instruments with an Ethernet based interface, the RJ-45 connection sockets have two integrated LED indicators, with standard Ethernet functionality:

- Amber: Ethernet speed
- Green: Ethernet link/activity

The tables below list the different LED indications:

● Green		
Pattern	Time	Indication
off	continuous	Power-off or program not running
on	continuous	Normal operation mode
short flash	0.1 sec on, 2 sec off	Valve Safe State mode; there is no bus communication (PROFIBUS DP, DeviceNet™, EtherCAT® and PROFINET). Valves are in safe state. This LED indication is also active when the instrument is in 'Initialization Mode' (parameter <i>Init Reset</i> = 73)
blink	0.2 sec on, 0.2 sec off	Special function mode; the instrument is busy performing a special function (e.g. auto-zero or self-test)
long flash	2 sec on, 0.1 sec off	Configuration mode; the 9-pin D-sub (power) connector is set for RS232 communication (ProPar) at baud rate 38400

● Red		
Pattern	Time	Indication
on	continuous	Critical error; the instrument needs servicing before it can be used
short flash	0.1 sec on, 2 sec off	<b>FLOW-BUS</b> Node occupied: re-install instrument <b>PROFIBUS DP</b> No data exchange between master and slave (automatic recovery) <b>Modbus</b> Data is being received or transmitted <b>DeviceNet™</b> Minor communication error <b>EtherCAT®</b> Instrument is not in OP mode <b>PROFINET</b> No application relation established
blink	0.2 sec on, 0.2 sec off	<b>FLOW-BUS</b> Waiting for communication <b>PROFIBUS DP</b> Not used <b>Modbus</b> Not used <b>DeviceNet™</b> No bus power <b>EtherCAT®</b> Not used <b>PROFINET</b> Not used
long flash	2 sec on, 0.1 sec off	<b>FLOW-BUS</b> Not used <b>PROFIBUS DP</b> Requested parameter not available <b>Modbus</b> Not used <b>DeviceNet™</b> Serious communication error; manual intervention needed <b>EtherCAT®</b> Configuration error <b>PROFINET</b> Configuration error (e.g. a requested parameter is not available)

● Green and ● red (alternating)		
Pattern	Time	Indication
slow wink	1 sec on, 1 sec off	Alarm indication; minimum/maximum alarm, power-up alarm, limit reached or batch size reached
normal wink	0.2 sec on, 0.2 sec off	Wink mode; by sending a command to the <i>Wink</i> parameter, the instrument flashes its LEDs, so that it can be located in the physical setup
fast wink	0.1 sec on, 0.1 sec off	Selected action started (after releasing the multifunctional switch)

**DeviceNet™ LED indications**

Specific LED indications are applicable to instruments with DeviceNet™ interface. Note: the 'NET' and 'MOD' LEDs are bi-colored LEDs (green/red). Refer to the DeviceNet™ manual, **document 9.17.026**, for more information.

**EtherCAT® LED indications**

Specific LED indications are applicable to instruments with EtherCAT® interface. Refer to the EtherCAT® manual, **document 9.17.063**, for more information.

**PROFINET LED indications**

Specific LED indications are applicable to instruments with PROFINET interface. Refer to the PROFINET manual, **document 9.17.095**, for more information.

## 3.8 Micro switch functions



Some special instrument functions can be started manually using the multifunctional switch near the indication LEDs. These functions are available in analog as well as in digital operation mode.



*The micro switch on top of the EL-FLOW® Prestige can be operated with a thin metal or hard plastic pin, e.g. the end of a paperclip.*

### 3.8.1 Normal operating functions

- In order to access these functions, press and hold the switch while the instrument is in normal operation mode (green LED lit continuously).
- As long as the switch is held, the LEDs show a repeating sequence of patterns, where each pattern indicates a function.
- All patterns in this sequence are continuous.
- Each pattern is shown for a number of seconds; in the table below, the column labeled *Hold time* indicates the time frame during which a pattern is shown.
- To start the required function, release the switch when the LEDs show the associated pattern.



 (green)	 (red)	Hold time	Function
off	off	0...1 sec	No action
off	off	1...4 sec	1. In case of a min/max alarm: reset alarm 2. FLOW-BUS: Auto-install to bus - lets instrument obtain free node address Note: min/max alarm (if any) has to be reset before auto install can be performed.
off	on	4...8 sec	Reset instrument; clear all warnings and error messages and restart the instrument
on	off	8...12 sec	Auto-zero; re-adjust the zero-point of the instrument (flow meters/controllers only)
on	on	12...16 sec	Enable FLASH mode for firmware update: <ul style="list-style-type: none"> <li>• the instrument shuts down and both LEDs are switched off</li> <li>• at the next power-up, the instrument will be active again</li> </ul>



- See [Adjusting zero point](#) for background information and instructions on how to adjust the zero point of an instrument.
- Do not adjust the zero point before having taken notice of the instructions.

### 3.8.2 Power-up functions





- In order to access these functions, press and hold the switch while powering up the instrument.
- As long as the switch is held, the LEDs show a repeating sequence of patterns, where each pattern indicates a function.
- All patterns in this sequence are flashing (0.2 sec on, 0.2 sec off).
- Each pattern is shown for a number of seconds; in the table below, the column labeled *Hold time* indicates the time frame within the sequence during which a pattern is shown.
- To start the required function, release the switch when the LEDs show the associated pattern.

 (green)	 (red)	Hold time	Function
off	off	0...4 sec	No action
off	on	4...8 sec	Restore factory settings (except communication settings)
on	off	8...12 sec	<ul style="list-style-type: none"> <li>• FLOW-BUS: auto install to bus; let the instrument obtain a free node address from the FLOW-BUS system</li> <li>• Other protocols: no action</li> </ul>
on	on	12...16 sec	Activate or deactivate configuration mode <ul style="list-style-type: none"> <li>• The 9-pin D-sub connector is set to RS-232 communication (<a href="#">ProPar</a>) at baud rate 38400</li> <li>• In configuration mode, the green LED blinks (2 seconds on, 0.1 second off)</li> <li>• Deactivate configuration mode by selecting this function again at the next power-up</li> </ul>

### 3.8.3 Control mode - readout/change

#### Reading control mode

- By briefly pressing the switch 2 times within 1 second in normal operation mode, the instrument shows its current control mode with a series of consecutive LED indication patterns.
- The number of flashes corresponds to the current value of parameter *Control Mode* (see [Special parameters](#)).





Step	Pattern	Indication
1	Green  	number of flashes indicates the tens of the parameter value
2	Red  	number of flashes indicates the units of the parameter value

Examples:

- for value 1 (control mode 'Analog input'), the green LED will flash 0 times and the red LED 1 time
- for value 22 (control mode 'Valve Safe State'), the green and red LED will each flash 2 times

#### Changing control mode

- By briefly pressing the switch 4 times with intervals of up to 1 second in normal operation mode, the instrument enters a state in which the control mode can be changed.
- This is done in 2 steps, each represented by a LED indication pattern (green or red; see table below).
- The number of flashes corresponds to the available values of parameter *Control Mode* (see [Special parameters](#)).
- At the start of each step, the according LEDs starts flashing fast (0.1 second on, 0.1 second off). By pressing and holding the switch, the associated action is started and the flashing slows (0.5 seconds on, 0.5 seconds off).

Step	Pattern	Maximum flash count	Action
1	Green  	2	set tens of parameter value
2	Red  	9	set units of parameter value



To execute a step, follow these instructions:

- Press and hold the switch (flashing slows)
- To select value 0 (zero), release the switch within 1 second, otherwise:
- Count the number of LED flashes
- Release the switch when the required value is reached
- In case you lose count, keep the switch pressed and wait until the flash count reaches its maximum and restarts

On completion of step 1, the instrument automatically advances to step 2. When both steps have been completed, the instrument returns to its normal operation mode.

If the switch is not pressed within 60 seconds after starting a step, all changes are canceled and the instrument returns to its normal operation mode.









Note that this procedure also sets the [default control mode](#) of the instrument (contrary to changing the control mode digitally).

### 3.8.4 Network settings - readout/change

#### Reading network settings

- By briefly pressing the switch 3 times with intervals of up to 1 second in normal operation mode, the instrument shows its current node address and baud rate with a series of consecutive LED indication patterns:

Step	Pattern	Indication
1	Green  	number of flashes indicates the tens of the node address
2	Red  	number of flashes indicates the units of the node address
3	Green and red (simultaneous)  	number of flashes indicates the baud rate

Examples:

- for node address 35, the green LED will flash 3 times and the red LED 5 times
- for node address 116, the green LED will flash 11 times and the red LED 6 times





On DeviceNet™ the node address is called MAC ID.

The number of flashes for the baud rate indication is associated with the following baud rates:

Number of flashes (index)	Baud rate					
	FLOW-BUS	Modbus (ASCII/RTU)	PROFIBUS DP	CANopen	DeviceNet™	Ethernet based
0			automatically detected			
1	187500	9600	9600	1000000	125000	100000000
2	400000	19200	19200	800000	250000	
3		38400	45450	500000	500000	
4		56000	93750	250000		
5		57600	187500	125000		
6		115200	500000	50000		
7		128000	1500000	20000		
8		256000	3000000	10000		
9			6000000			
10			12000000			

### Changing network settings

- By briefly pressing the switch 5 times with intervals of up to 1 second in normal operation mode, the instrument enters a state in which the node address and baud rate can be changed (non-Ethernet based protocols only; for Ethernet based protocols, network parameters are configured by the fieldbus master and cannot be set on the instrument).
- Changing network parameters with the multifunctional switch is done in 3 steps, each represented by a LED indication pattern (see table below).
- At the start of each step, the according LED(s) start(s) flashing fast (0.1 second on, 0.1 second off). By pressing and holding the switch, the associated action is started and the flashing slows (0.5 seconds on, 0.5 seconds off).

Step	Pattern	Maximum flash count	Action
1	Green 	12	set tens of node address
2	Red 	9	set units of node address
3	Green and red (simultaneous) 	10*	set baud rate index (number of flashes)

\*) maximum count depends on the supported baud rates of the fieldbus. See the baud rate table above for supported baud rates and associated indexes.

To execute a step, follow these instructions:

- Press and hold the switch (flashing slows)
- To select value 0 (zero), release the switch within 1 second, otherwise:
- Count the number of LED flashes
- Release the switch as soon as the required value is reached
- In case you lose count, keep the switch pressed and wait until the flash count reaches its maximum and restarts

On completion of a step, the instrument automatically advances to the next step. When all required steps have been completed, the instrument returns to its normal operation mode.

If the switch is not pressed within 60 seconds after starting a step, all changes in the previous steps are cancelled and the instrument returns to its normal operation mode.

## 3.9 Basic parameters and properties

This section describes the most common parameters for digital communication with the instrument.



*Digital parameters are most easily accessible via FlowPlot or FlowView software or a Bronkhorst® readout and control unit (E-8000 or BRIGHT).*

### 3.9.1 General

This section describes the most commonly used parameters for digital operation of the EL-FLOW® Prestige. Descriptions are grouped by category in tables as shown below:

Type	Access	Range	FlowDDE	FLOW-BUS	Modbus
[type]	RW 	[x]...[y]	[DDE par]	[Pro]/[Par]	[address]/[register]



*In this manual, parameter names are printed in italics (reverted to normal where embedded in italics, like in this tip).*

#### Type

Unsigned char 1 byte unsigned integer (0...255)  
 Unsigned int 2 byte unsigned integer, MSB first (0...65535)  
 Unsigned long 4 byte unsigned integer, MSB first (0...4294967295)  
 Float 4 byte floating point, IEEE 32-bit single precision, MSB first  
 Unsigned char [x] x byte text string

#### Access

R Parameter value can be read  
 W Parameter value can be written  
 Parameter is secured and only accepts values if parameter *Init Reset* is set to 'unlocked' first

**Range**

Some parameters only accept values within a certain range:

[x]                    Minimum value  
[y]                    Maximum value

**FlowDDE**

Parameter number within FlowDDE

**FLOW-BUS**

FLOW-BUS uses the ProPar protocol, where parameters are identified by a unique combination of a process number and a parameter number.



- For more information about setting up a FLOW-BUS network with Bronkhorst® instruments, consult the FLOW-BUS manual (see [Documentation](#)).
- For more information about the ProPar protocol, consult the RS-232 manual (see [Documentation](#)).

**Modbus**

In the Modbus protocol, parameters are accessed by specifying their unique decimal register number or corresponding PDU address (Protocol Data Unit). The PDU address is the hexadecimal translation of the register number minus 1, e.g. register number 1 corresponds to PDU address 0x0000, register number 11 corresponds to PDU address 0x000A:

[address]            Hexadecimal PDU address  
[register]            Decimal register number

Modbus address blocks are two bytes big. Larger data types use up to 8 subsequent address blocks, resulting in a maximum variable length of 16 bytes. Values longer than the maximum length are truncated.



For more detailed information about setting up a Modbus network with Bronkhorst® instruments, consult the Modbus manual (see [Documentation](#)).

**Other interface protocols**

Parameter descriptions in this document are based on their availability with FLOW-BUS, Modbus or RS-232 (ProPar) communication. Due to limitations in, for example, memory capacity or communication properties, definition files for other fieldbus systems usually do not make all parameters available.



Not all parameters described in this document are necessarily available with all digital interface types. For information about parameter access and availability for Bronkhorst® instruments in a specific fieldbus network, consult the according [fieldbus manual](#).

**3.9.2 Measurement and control (basic)****Measure**

Type	Access	Range	FlowDDE	FLOW-BUS	Modbus
Unsigned int	R	0...41942 (65535*)	8	1/0	0x0020/33

This parameter indicates the flow metered by the instrument. The signal of 0...100% is presented in a range of 0...32000. The maximum measured value output is 131.07%, which translates to 41942.

A floating point pendant of the measured value is also available in the capacity unit for which the instrument was set; see section [Measurement and control \(advanced\)](#).



\*In case the instrument is prepared for bi-directional measurement, the negative signals with an output range of -73.73...-0.003% are represented by the range of 41943...65535, whereas the positive signals 0...131.07% are still represented by the range of 0...41942. (FlowDDE converts the numbers to negative values automatically).

**Setpoint**

Type	Access	Range	FlowDDE	FLOW-BUS	Modbus
Unsigned int	RW	0...32000	9	1/1	0x0021/34

This parameter is used to set the required flow rate for the controller. The signals have the same range as *Measure*, but the setpoint is limited between 0 and 100% (0...32000).

A floating point pendant of the setpoint is also available in the capacity unit for which the instrument was set; see section [Measurement and control \(advanced\)](#).



To convert Measure and Setpoint to actual mass or volume flows (*fMeasure* and *fSetpoint* respectively), use parameters Capacity 100% and Capacity Unit (see [Fluid set](#))

**3.9.2.1 Secondary outputs****Temperature**

Type	Access	Range	FlowDDE	FLOW-BUS	Modbus
Float	R	-250...500	142	33/7	0xA138...0xA139/41273...41274

This parameter returns the internal temperature in the instrument housing in °C, which is an approximation of the actual media temperature.

**Pressure**

Type	Access	Range	FlowDDE	FLOW-BUS	Modbus
Float	RW	0...3.4E+38	143	33/8	0xA140...0xA141/41281...41282

- For regular EL-FLOW® Prestige models, the default value of this parameter is 1bar(a) after powering up.
- For the EL-FLOW® Prestige PI (with an internal pressure sensor) and for regular models with an externally connected pressure sensor, this parameter returns the measured (inlet) pressure in bar(a).

**3.9.3 Device identification****User Tag**

Type	Access	Range	FlowDDE	FLOW-BUS	Modbus
Unsigned char[16]	RW	-	115	113/6	0xF130...0xF137/ 61745...61752

With this parameter, the instrument can be given a custom tag name, with a maximum of 16 characters.

**Customer Model**

Type	Access	Range	FlowDDE	FLOW-BUS	Modbus
Unsigned char[16]	RW 	-	93	113/4	0xF120...0xF127/ 61729...61736

This parameter is used to add extra information to the model number information, such as a customer-specific model number.

**Serial Number**

Type	Access	Range	FlowDDE	FLOW-BUS	Modbus
Unsigned char[20]	R	-	92	113/3	0xF118...0xF11F/ 61721...61728

Instrument serial number for identification.

**BHT Model Number**

Type	Access	Range	FlowDDE	FLOW-BUS	Modbus
Unsigned char[35]	RW 	-	91	113/2	0xF110...0xF117/ 61713...61720

This parameter shows the Bronkhorst® instrument model type information.

**Firmware Version**

Type	Access	Range	FlowDDE	FLOW-BUS	Modbus
Unsigned char[6]	R	-	105	113/5	0xF128...0xF12A/ 61737...61739

Revision number of the firmware

**Identification Number**

Type	Access	Range	FlowDDE	FLOW-BUS	Modbus
Unsigned char	RW 	0...255	175	113/12	0x0E2C/3629

Bronkhorst® (digital) device type identification number.

**Device Type**

Type	Access	Range	FlowDDE	FLOW-BUS	Modbus
Unsigned char[6]	R	-	90	113/1	0xF108...0xF10A/ 61705...61707

Device type information string; this parameter contains an abbreviation referring to the identification number.

**3.9.4 Alarms and counter**

*Alarm and counter settings are most easily accessible via FlowPlot or FlowView software or a Bronkhorst® readout and control unit (E-8000 or BRIGHT).*

*For more information about the alarm and counter parameters, see the according sub sections under [Advanced parameters and properties](#).*

**3.10 Adjusting zero point**

The zero point (the signal that corresponds to zero flow) of a Bronkhorst® flow meter/controller is factory adjusted at approximately 20 °C and atmospheric pressure, with the instrument in an upright position. If the ambient conditions or mounting position are significantly different, the instrument might detect a flow when actually there is none. In that case, the instrument needs to be adapted to the new conditions by re-adjusting the zero point.

Zeroing an instrument requires that:

- the ambient conditions (temperature, pressure) match those of the operating environment of the instrument.
- the instrument is filled homogeneously and pressurized with the operational media, according to the typical process conditions.
- the instrument has been warmed up sufficiently.
- there is absolutely no flow through the instrument; preferably, this is achieved by closing a valve immediately after the outlet of the instrument (control valve, shut-off valve).



*Blocking the flow through the instrument is essential; zeroing an instrument while there is still a flow will lead to measurement errors.*

Adjusting the zero point of an instrument can be done by the following methods:

- manually (using the multifunctional switch)
- digitally (via RS232 or fieldbus)
- with the autozero function of a Bronkhorst® readout and control unit (E-8000/BRIGHT)

Once started, the procedure takes approximately 5 seconds to complete (longer if the output signal is unstable), regardless of the preferred method.

### 3.10.1 Manual procedure

To start the autozero function with the multifunctional switch, follow these instructions:

1. Change the setpoint of the instrument to 0 (zero).
2. Press and hold the multifunctional switch. After 4 seconds, the red LED ● lights up; another 4 seconds later the red LED extinguishes and the green LED ● lights up.
3. At that moment (which is after 8 to 12 seconds), release the switch.

The green LED starts to blink fast, indicating that the autozero procedure is in progress. After (successful) completion, the green LED lights up continuously, while the output signal is 0 % (parameter *Measure* = 0).

### 3.10.2 Digital procedure



*Bronkhorst FlowSuite and FlowPlot provide an easy way to adjust the zero point of an instrument using RS-232 communication; the Autozero function automatically performs the procedure described here.*

To adjust the zero point using digital communication, set parameter values in the following sequence (see section [Basic parameters and properties](#) for more information about instrument parameters):

Sequence #	Parameter	Value	Action
1	Setpoint or fSetpoint	0	stop flow
2	Init Reset	64	unlock secured parameters
3	Control Mode	9	enable calibration mode
4	Calibration Mode	0	reset calibration mode
5	Calibration Mode	9	start zeroing

The green LED starts to blink fast, indicating that the zeroing procedure is in progress. On completion, the green LED lights up, while the output signal is 0 % (parameter *Measure* = 0). At the same time, parameter *Control Mode* returns to its initial value. If the procedure is successful, parameter *Calibration Mode* changes to 0 (idle). If the procedure fails, *Calibration Mode* changes to 255.



*After performing the procedure, remember to set parameter Init Reset to value 82 to lock secured parameters.*

## 4 Advanced operation

### 4.1 Sealing material compatibility

**EL-FLOW® Prestige** instruments are fitted from factory with internal seals compatible with the gas type(s) as specified at ordering time. Before using other media, always check their compatibility with the applied sealing materials. Check the [model key](#) on the serial number label to see which sealing materials have been incorporated in your specific instrument. When in doubt, do not hesitate to contact your Bronkhorst representative for more information.

The table below lists compatibility with some commonly used gases:

Gas	Sealing material		
	FKM (Viton®)	EPDM	FFKM (Kalrez®)
Air	✓	✓	✓
Ar (Argon)	✓	✓	✓
CH <sub>4</sub> (Methane)	✓	✗	✓
CO (Carbon monoxide)	✓	✓	✓
CO <sub>2</sub> (Carbon dioxide)	max 10 bar(g), 50°C	✓	max 10 bar(g), 50°C (ED compound <sup>1</sup> max 30 bar(g))
C <sub>2</sub> F <sub>6</sub> (Freon-116)	✓	✓	✓
C <sub>2</sub> H <sub>2</sub> (Acetylene)	✓/✗ <sup>2</sup>	✓	✓
C <sub>2</sub> H <sub>4</sub> (Ethylene)	max 10 bar(g) <sup>3</sup>	max 10 bar(g)	max 10 bar(g)
C <sub>2</sub> H <sub>6</sub> (Ethane)	✓	✗	✓
C <sub>3</sub> H <sub>6</sub> #2 (Propylene)	max 10 bar(g)	✗	max 58 bar(g) <sup>3</sup>
C <sub>3</sub> H <sub>8</sub> (Propane)	✓	✗	✓
Cl <sub>2</sub> (Chlorine)	✓	✗	✓
He (Helium)	✓	✓	✓
H <sub>2</sub> (Hydrogen)	✓	✓	✓
H <sub>2</sub> S (Hydrogen sulfide)	✗	✓	✓
Kr (Krypton)	✓	✓	✓
NF <sub>3</sub> (Nitrogen trifluoride)	✗	✗	✓
NH <sub>3</sub> (Ammonia)	✗	✓	✓
NO (Nitric oxide)	✗	✗	✓
N <sub>2</sub> (Nitrogen)	✓	✓	✓
N <sub>2</sub> O (Nitrous oxide)	max 20 bar(g), 50°C	✓	✓
O <sub>2</sub> (Oxygen)	✓	✓	✓
SF <sub>6</sub> (Sulfur hexafluoride)	✗	✓	✓
SiH <sub>4</sub> (Silane)	✓/✗ <sup>2</sup>	✗	✓
Xe (Xenon)	✓	✓	✓

1) ED: Explosive Decompression resistant

2) Only O-ring seals, not suitable for control valve plunger

3) For higher pressures ED compounds are used



- Always make sure that the applied process gases or mixtures thereof are compatible with the applied sealing materials.
- Do not exceed the specified maximum operating pressure and temperature. Using the instrument outside the specified operating limits might lead to serious damage and dangerous situations.
- The gas(es) used in the fluid system in which the instrument is mounted should be clean and dry.

## 4.2 Advanced parameters and properties

### 4.2.1 Measurement and control (advanced)

#### fMeasure

Type	Access	Range	FlowDDE	FLOW-BUS	Modbus
Float	R	-3.4E+38... 3.4E+38	205	33/0	0xA100...0xA101/ 41217...41218

This parameter represents the value of parameter *Measure*, expressed in the selected *Capacity Unit*. Its value is calculated from the dimensionless value of *Measure*, using the fluid set parameters *Capacity 100%* and *Capacity Unit*.

#### Fsetpoint

Type	Access	Range	FlowDDE	FLOW-BUS	Modbus
Float	RW	0...3.4E+38	206	33/3	0xA118...0xA119/ 41241...41242

This parameter represents the value of parameter *Setpoint*, expressed in the selected *Capacity Unit*. Conversion between *Fsetpoint* and the dimensionless value of *Setpoint* uses fluid set parameters *Capacity 100%* and *Capacity Unit*.

#### Setpoint Slope

Type	Access	Range	FlowDDE	FLOW-BUS	Modbus
Unsigned int	RW	0...30000	10	1/2	0x0022/35

The value of this parameter represents the time it would take to adjust the setpoint if it were changed from 0 to 100 %. This feature can be used to smooth 'nervous' controller behavior, e.g. to reduce setpoint overshoot or undershoot. The supported range corresponds to 0...3000 seconds. Default value = 0.

Example:

If *Setpoint Slope* = 100 it will take 10 seconds to adjust the setpoint if it is changed from 0 to 100%. A setpoint change of 20% will take  $(20\%/100\%)*10$  seconds = 2 seconds.

#### Analog Input

Type	Access	Range	FlowDDE	FLOW-BUS	Modbus
Unsigned int	R	0...65535	11	1/3	0x0023/36

This parameter contains a digital translation of the analog input signal (if applicable).

#### Valve Output

Type	Access	Range	FlowDDE	FLOW-BUS	Modbus
Unsigned long	RW	0... 16777215	55	114/1	0xF208...0xF209/61961...61962

This parameter represents the controller output signal for control valve operation.

#### Sensor Type

Type	Access	Range	FlowDDE	FLOW-BUS	Modbus
Unsigned char	RW 	0...255	22	1/14	0x002E/47

For the EL-FLOW® Prestige the following values are valid:

- 3: Gas flow sensor, controller enabled
- 131: Gas flow sensor, controller disabled



## 4.2.2 Special parameters

### Init Reset

Type	Access	Range	FlowDDE	FLOW-BUS	Modbus
Unsigned char	RW	82/64	7	0/10	0x000A/11

*Init Reset* is used to unlock secured parameters (marked with a  symbol) for writing. It supports the following values:

Value	Description
64	unlocked, secured parameters can be read and written to
82	locked, secured parameters are read-only

At power-up, *Init Reset* is always set to 'Locked' (value 82).

### Reset

Type	Access	Range	FlowDDE	FLOW-BUS	Modbus
Unsigned char	R	0...7	114	115/8	0x0E68/3689

This parameter is used to reset the program, counter or alarms.

Value	Description
0	No reset
1	Reset counter
2	Reset alarm
3	Reset counter
4	Reset and disable counter
5	Reset firmware program (soft reset)
6	Reset <i>Alarm info</i> error bit
7	Reset <i>Alarm info</i> warning bit



*The Reset parameter may be disabled by Reset Alarm Enable or Reset Counter Enable. Make sure the value is accepted by sending value 0 first.*

### Wink

Type	Access	Range	FlowDDE	FLOW-BUS	Modbus
Unsigned char [27]	W	0...9*	1	0/0	0x0000/1

Sending any text string value between 1 and 9 to this parameter makes the indication LEDs (if present) blink for a couple of seconds. This can be useful in order to identify a specific device in a large fieldbus network.

\*) Modbus only supports value 14592

### Control Mode

Type	Access	Range	FlowDDE	FLOW-BUS	Modbus
Unsigned char	RW	0...255	12	115/1	0x0024/37

*Control Mode* is used to select different control modes of the instrument and determines from which source(s) it accepts a setpoint.

The following modes are available:

Value	List option	Description	Setpoint source
0	Bus/RS232	Normal digital operation	Fieldbus or RS-232
1	Analog input	Normal analog operation	Analog input
2	FLOW-BUS slave	Acting as slave instrument on FLOW-BUS	FLOW-BUS master
3	Valve close	Controller disabled, valve closed	
4	Controller idle	Controller disabled, valve frozen in current position	
7	Setpoint 100%	Setpoint fixed at 100 %	
8	Valve fully open	Controller disabled, valve fully open	
9	Calibration mode	Calibration mode enabled	
10	Analog slave	Acting as slave of other instrument in analog mode	Analog input
12	Setpoint 0%	Setpoint fixed at 0%	
13	FLOW-BUS analog slave	Acting as slave of other instrument on FLOW-BUS, slave factor set by analog input signal	Analog input
18	RS232	Controlling, <a href="#">default/safe state</a> disabled	Fieldbus or RS-232
20	Valve steering	Controller disabled, setpoint redirected to <i>Valve Output</i>	
21	Analog valve steering	Controller disabled, analog input redirected to <i>Valve Output</i>	
22	Valve safe state	Instrument in <a href="#">default/safe state</a>	

- Default value: 0 or 1 (as ordered).
- If *Control Mode* is changed to value 0, 1, 9 or 18, the instrument returns to the default value at the next power-up or reset. Other values are persistent.
- *Control Mode* 18 prevents the instrument from assuming its [default/safe state](#) in the event of a digital communication failure.
- The column labeled *List option* shows the control modes as used in Bronkhorst® software.

#### Calibration Mode

Type	Access	Range	FlowDDE	FLOW-BUS	Modbus
Unsigned char	RW 	0, 9, 255	58	1/4	0x0E61/3682

After enabling calibration mode by means of parameter *Control Mode*, this parameter is used to start the autozero function of the flow sensor. The following modes are supported:

Value	Description
0	Idle (no action)
9	Start zeroing
255	Error (result of previous calibration mode)



- See section [Changing default control mode](#) for more information about the default control mode.
- See section [Control mode - readout/change](#) for information about changing the control mode using the multifunctional switch.
- Parameter values 3, 8, 20 and 21 can be used regardless if the controller is enabled or not. See also parameter *Sensor Type*
- Control Mode values 2 and 13 are only effective in a FLOW-BUS system; see also section [Master/slave configuration \(FLOW-BUS\)](#).

#### 4.2.3 Fluid set



For changing fluid, flow range or operating conditions, using the FlowTune software is advised. FlowTune checks any changes for compatibility of the process conditions with the instrument. When the parameters described in this section are changed manually, no such checks are performed, and the instrument output may become disordered or the instrument may even get damaged if used in conditions the instrument is not suited for. When in doubt, consult your Bronkhorst representative.

**Fluid Set Index**

Type	Access	Range	FlowDDE	FLOW-BUS	Modbus
Unsigned char	RW	0...7	24	1/16	0x0030/49

With this parameter, any of the pre-configured fluids (up to 8) can be selected. Each fluid has its specific (configurable) properties, such as *Fluid Name*, *Capacity*, etc.  
Default value: 0 (fluid 1).

Note that the selected value is equal to the fluid number minus 1 (value 0 corresponds to fluid 1, value 1 to fluid 2, etc.)

**Fluid Name**

Type	Access	Range	FlowDDE	FLOW-BUS	Modbus
Unsigned char[10]	RW 	-	25	1/17	0x8188...0x818C/33161...33165

This parameter contains the name of the selected fluid.

**Capacity 100%**

Type	Access	Range	FlowDDE	FLOW-BUS	Modbus
Float	RW 	1E-10... 1E+10	21	1/13	0x8168...0x8169/33129...33130

- This parameter represents the 100 % readout/control value (span), expressed in the *Capacity Unit* of the selected fluid.
- *Capacity 100%* is scaled when *Inlet Pressure*, *Fluid Temperature* or *Fluid Name* is changed for the selected fluid.

**Capacity Unit**

Type	Access	Range	FlowDDE	FLOW-BUS	Modbus
Unsigned char[7]	RW 	see below	129	1/31	0x81F8...0x81FB/33273...33276

This parameter represents the unit in which *Capacity 100%* is expressed.  
Available units:

Mass flow	Normal volume flow (1.01325 bar(a), 0 °C)	Standard volume flow (1.01325 bar(a), 20 °C)	Custom volume flow ( <i>Capacity Unit Type Pressure</i> , <i>Capacity Unit Type Temperature</i> )
ug/h, ug/min, ug/s, mg/h, mg/min, mg/s, g/h, g/min, g/s, kg/h, kg/min, kg/s	uln/h, uln/min, uln/s, mln/h, mln/min, mln/s, ln/h, ln/min, ln/s, ccn/h, ccn/min, ccn/s, mm3n/h, mm3n/m, mm3n/s, cm3n/h, cm3n/m, cm3n/s, m3n/h, m3n/min, m3n/s, scfh, scfm, scfs, sccm, slm	uls/h, uls/min, uls/s, mls/h, mls/min, mls/s, ls/h, ls/min, ls/s, ccs/h, ccs/min, ccs/s, mm3s/h, mm3s/m, mm3s/s, cm3s/h, cm3s/m, cm3s/s, m3s/h, m3s/min, m3s/s	ul/h, ul/min, ul/s, ml/h, ml/min, ml/s, l/h, l/min, l/s, cc/h, cc/min, cc/s, mm3/h, mm3/m, mm3/s, cm3/h, cm3/m, cm3/s, m3/h, m3/min, m3/s, cfh, cfm, cfs



Because of the maximum string length (7 characters), some unit names are abbreviated, for instance mm3n/m means mm<sup>3</sup>n/min.

**Capacity Unit Type Temperature**

Type	Access	Range	FlowDDE	FLOW-BUS	Modbus
Float	RW 	-273.15... 3.4E+38	245	33/10	0xA150...0xA151/41297...41298

This parameter defines a reference temperature for conversion of the measured mass flow to a volume flow. See also parameters *Capacity Unit* and *Counter Unit*.

**Capacity Unit Type Pressure**

Type	Access	Range	FlowDDE	FLOW-BUS	Modbus
Float	RW 	0...3.4E+38	246	33/11	0xA158...0xA159/41305...41306

This parameter defines a reference pressure for conversion of the measured mass flow to a volume flow. See also parameters *Capacity Unit* and *Counter Unit*.

**Controller Speed**

Type	Access	Range	FlowDDE	FLOW-BUS	Modbus
Float	RW	0.2...5	254	114/30	0xF2F0...0xF2F1/62193...62194

This parameter sets the overall controller speed factor for the selected fluid set. *Controller Speed* is set ex factory between value '0.5' (slow) and '2' (fast). The default value is '1'. Slower or faster settings are possible between values 0.2 and 5 at the customer's responsibility.

**4.2.3.1 Advanced fluid set parameters**

Note that the parameters described in this section do not contain any actual measurement values, but only fixed reference values, which can be used for capacity calculations, etc.

**Inlet Pressure**

Type	Access	Range	FlowDDE	FLOW-BUS	Modbus
Float	RW 	0...3.4E+38	178	113/13	0xF168...0xF169/61801...61802

Upstream pressure of the selected fluid in bar(a)

**Outlet Pressure**

Type	Access	Range	FlowDDE	FLOW-BUS	Modbus
Float	RW 	0...3.4E+38	179	113/14	0xF170...0xF171/61809...61810

Downstream pressure of the selected fluid in bar(a).

**Fluid Temperature**

Type	Access	Range	FlowDDE	FLOW-BUS	Modbus
Float	RW 	-250...500	181	113/16	0xF180...0xF181/61825...61826

Temperature of the selected fluid in °C.

**Density**

Type	Access	Range	FlowDDE	FLOW-BUS	Modbus
Float	RW 	0...3.4E+38	170	33/21	0xA1A8...0xA1A9/41385...41386

Density of the selected fluid in kg/m<sup>3</sup>

**Heat Capacity**

Type	Access	Range	FlowDDE	FLOW-BUS	Modbus
Float	RW 	0...3.4E+38	250	113/18	0xF190...0xF191/61841...61842

Heat capacity of the selected fluid in J/kg·K

**Thermal Conductivity**

Type	Access	Range	FlowDDE	FLOW-BUS	Modbus
Float	RW 	0...3.4E+38	251	113/20	0xF1A0...0xF1A1/61857...61858

Thermal conductivity of the selected fluid in W/m·K

**Viscosity**

Type	Access	Range	FlowDDE	FLOW-BUS	Modbus
Float	RW 	0...3.4E+38	252	113/21	0xF1A8...0xF1A9/61865...61866

Dynamic viscosity of the selected fluid in Pa·s

**4.2.3.2 Fluid mixture parameters****Mix Fraction Type**

Type	Access	Range	FlowDDE	FLOW-BUS	Modbus
Unsigned char	RW 	0...2	346	126/4	0x0FC4/4037

Sets the fraction type of the mixture:

Value	Description
0	Volume fraction
1	Mass fraction
2	Mole fraction

**Mix Volume Temperature**

Type	Access	Range	FlowDDE	FLOW-BUS	Modbus
Float	RW 	-250...500	347	126/5	0xFE28...0xFE29/65065...65066

Temperature of the mixture in °C. The value of this parameter is only relevant if *Mix Fraction Type* = 0.

**Mix Volume Pressure**

Type	Access	Range	FlowDDE	FLOW-BUS	Modbus
Float	RW 	0...3.4E+38	348	126/6	0xFE30...0xFE31/65073...65074

Pressure of the mixture in bar(a). The value of this parameter is only relevant if *Mix Fraction Type* = 0.

**Mix Component Index**

Type	Access	Range	FlowDDE	FLOW-BUS	Modbus
Unsigned char	RW	0...4	349	126/7	0x0FC7/4040

Index of the selected component of the mixture (max. 5 components).

**Mix Component Fraction**

Type	Access	Range	FlowDDE	FLOW-BUS	Modbus
Float	RW 	0...1	350	126/8	0xFE40...0xFE41/65089...65090

Mix fraction of the selected mix component (*Mix Component Index*). The value range corresponds to 0...100%. The sum of the all mix fractions must be equal to 1.

If the value is 0, the next component slots are ignored.

**Mix Component Fluid Name**

Type	Access	Range	FlowDDE	FLOW-BUS	Modbus
Unsigned char[10]	RW 	-	351	126/9	0xFE48...0xFE4C/65097...65101

This parameter contains the fluid name of the selected mix component (*Mix Component Index*). This parameter may contain one of two value types:

- Gas name, e.g. 'N2', 'He', 'C3H6 #2'.
- CAS Registry Number, e.g. '7727-37-9', '7440-59-7', '115-07-1'

If the parameter contains no name, the next component slots are ignored.

#### 4.2.4 Alarms



Alarm settings are most easily accessible using Bronkhorst FlowSuite, FlowPlot or FlowView or a Bronkhorst® readout and control unit.

The built-in alarm functionality can be used to handle different alarm types:

- system errors and warnings
- min/max alarms
- response alarms
- batch alarms
- master/slave alarms

The alarm type can be set with parameter *Alarm Mode*. When an alarm is activated, the type can be read out using parameter *Alarm Info*. An automatic setpoint change can be set using the parameters *Alarm Setpoint Mode* and *Alarm New Setpoint*. It is also possible to set an alarm delay, to prevent overreaction to small disturbances, using parameter *Alarm Delay Time*. The methods by which an alarm can be reset are controlled by *Reset Alarm Enable*.

##### Alarm Mode

Type	Access	Range	FlowDDE	FLOW-BUS	Modbus
Unsigned char	RW	0...3	118	97/3	0x0C23/3108

Available modes:

Value	Description
0	Alarm off
1	Alarm on absolute limits
2	Alarm on limits related to setpoint (response alarm)
3	Alarm at power-up(e.g. after power-down)

(On DeviceNet™ instruments, only modes 0 and 1 are available)

##### Alarm Info

Type	Access	Range	FlowDDE	FLOW-BUS	Modbus
Unsigned char	R	0...255	28	1/20	0x0034/53

This parameter provides information about the event type(s) that triggered an alarm situation. The value is a bitwise summation of the issued alarm types; convert the value to binary to see which types are issued. The following alarm types can be issued:

Bit	Value	Type	Description
0	1	Error	Error flag raised
1	2	Warning	Warning flag raised
2	4	Minimum alarm	<i>Measure</i> < <i>Alarm minimum limit</i>
3	8	Maximum alarm	<i>Measure</i> > <i>Alarm maximum limit</i>
4	16	Batch counter alarm	Batch counter reached its limit
5	32	<ul style="list-style-type: none"> <li>• This bit only: Power-up alarm</li> <li>• If combined with bit 2 or 3: Response alarm</li> </ul>	Alarm possibly caused by a power dip Difference between <i>Measure</i> and <i>Setpoint</i> too big
6	64	Master/slave alarm	Setpoint out of limits (caused by <i>Slave factor</i> )
7	128	Hardware alarm	Hardware error

##### Alarm Delay Time

Type	Access	Range	FlowDDE	FLOW-BUS	Modbus
Unsigned char	RW	0...255	182	97/7	0x0C27/3112

This value represents the time in seconds the alarm action will be delayed when an alarm limit has been exceeded. This value also delays the alarm off action if an alarm limit is no longer exceeded.  
Default value = 0.

**Alarm Maximum Limit**

Type	Access	Range	FlowDDE	FLOW-BUS	Modbus
Unsigned int	RW	0...32000	116	97/1	0x0C21/3106

Maximum limit for *Measure* to activate the maximum alarm situation (after *Alarm Delay Time*). Range 0...32000 represents 0...100% signal. *Alarm Maximum Limit* must be greater than *Alarm Minimum Limit*.  
Default value: 0.

**Alarm Minimum Limit**

Type	Access	Range	FlowDDE	FLOW-BUS	Modbus
Unsigned int	RW	0...32000	117	97/2	0x0C22/3107

Minimum limit for *Measure* to activate the minimum alarm situation (after *Alarm Delay Time*). Range 0...32000 represents 0...100% signal. *Alarm Minimum Limit* must be smaller than *Alarm Maximum Limit*.  
Default value: 0.

**Alarm Setpoint Mode**

Type	Access	Range	FlowDDE	FLOW-BUS	Modbus
Unsigned char	RW	0...1	120	97/5	0x0C25/3110

Specifies whether or not to change the setpoint after an alarm situation is activated.

Value	Description
0	No setpoint change (default)
1	Change setpoint to <i>Alarm new setpoint</i>

**Alarm New Setpoint**

Type	Access	Range	FlowDDE	FLOW-BUS	Modbus
Unsigned int	RW	0...32000	121	97/6	0x0C26/3111

New (safe) setpoint during an alarm until reset. Range 0...32000 represents 0...100% setpoint.  
Default value: 0

**Reset Alarm Enable**

Type	Access	Range	FlowDDE	FLOW-BUS	Modbus
Unsigned char	RW	0...15	156	97/9	0x0C29/3114

Available reset methods. The value is a bitwise summation of the enabled methods; convert the value to binary to see which methods are enabled.  
Default value: 15 (all bits/methods enabled)

The following methods are supported:

Bit	Value	Description
0	1	By hardware switch (if present)
1	2	Externally (obsolete)
2	4	By parameter <i>Reset</i>
3	8	Automatically (when alarm conditions no longer apply)

## 4.2.5 Counter



- Counter settings are most easily accessible using Bronkhorst FlowSuite, FlowPlot or FlowView or a Bronkhorst® readout and control unit.
- When the instrument is powered down, it remembers the state of the counter. If the counter is active when the instrument is powered down, it is activated when powered up and then continues to count from the value at the time of power down.

### Counter Mode

Type	Access	Range	FlowDDE	FLOW-BUS	Modbus
Unsigned char	RW	0...2	130	104/8	0x0D08/3337

Available modes:

Value	Description
0	Counter off (default)
1	Counting up continuously
2	Counting up until limit reached (set by <i>Counter Limit</i> )

### Counter Unit

Type	Access	Range	FlowDDE	FLOW-BUS	Modbus
Unsigned char[4]	RW	see table below	128	104/7	0xE838...0xE839/59449...59450

This parameter contains the name of the counter readout unit.

*Counter Unit* supports the following values:

Mass	Normal volume (1.01325 bar(a), 0 °C)	Standard volume (1.01325 bar(a), 20 °C)	Custom volume (Capacity Unit Pressure, Capacity Unit Type Temperature)
ug, mg, g, kg	uln, mln, ln, mm3n, cm3n, dm3n, m3n	uls, mls, ls, mm3s, cm3s, dm3s, m3s	ul, ml, l, mm3, cm3, dm3, m3



Parameter [Density](#) (FlowDDE ID 170) is used to calculate Custom volume.

### Counter Value

Type	Access	Range	FlowDDE	FLOW-BUS	Modbus
Float	RW	0... 10000000	122	104/1	0xE808...0xE809/59401...59402

Current counter value in units selected with parameter *Counter Unit*.

### Counter Limit

Type	Access	Range	FlowDDE	FLOW-BUS	Modbus
Float	RW	0...9999999	124	104/3	0xE818...0xE819/59417...59418

Counter limit/batch size in units selected with parameter *Counter Unit*.

Default value: 0.



**Counter Setpoint Mode**

Type	Access	Range	FlowDDE	FLOW-BUS	Modbus
Unsigned char	RW	0...1	126	104/5	0x0D05/3334

Specifies whether or not to change the setpoint after reaching the counter limit.

Value	Description
0	No setpoint change (default)
1	Change setpoint to <i>Counter new setpoint</i>

**Counter New Setpoint**

Type	Access	Range	FlowDDE	FLOW-BUS	Modbus
Unsigned int	RW	0...32000	127	104/6	0x0D06/3335

New (safe) setpoint when a counter limit is reached until reset. Range 0...32000 represents 0...100% setpoint. Default value: 0

**Reset Counter Enable**

Type	Access	Range	FlowDDE	FLOW-BUS	Modbus
Unsigned char	RW	0...15	157	104/9	0x0D09/3338

Available reset methods. The value is a bitwise summation of the enabled reset methods; convert the value to binary to see which methods are enabled.

Default value: 7 (bits/methods 0, 1 and 2 enabled)

The following methods are supported:

Bit	Value	Description
0	1	By hardware switch (if present)
1	2	Externally (obsolete)
2	4	By parameter <i>Reset</i>
3	8	Automatically (e.g. when counter value is reset)

**4.2.6 Network configuration**

Changes made to the network settings will **not** be restored by a factory reset.

**Communication via fieldbus connection (RS485)**

Use the following parameters to configure the instrument for communication via the fieldbus connection on top of the instrument (parameter values can be changed via the RS232 interface):

**Fieldbus1 Address**

Type	Access	Range	FlowDDE	FLOW-BUS	Modbus
Unsigned char	RW	0...255	199	125/10	0x0FAA/4011

**Fieldbus1 Baud Rate**

Type	Access	Range	FlowDDE	FLOW-BUS	Modbus
Unsigned long	RW	0...1.0E10	201	125/9	0xFD48...0xFD49/64841...64842

**Fieldbus1 Parity**

Type	Access	Range	FlowDDE	FLOW-BUS	Modbus
Unsigned char	RW	0...2	335	125/12	0x0FAC/4013

The following values are supported:

Value	Description
0	No parity
1	Odd parity
2	Even parity

#### Communication via power supply connection (RS232/RS485)

Use the following parameters to configure the instrument for communication via the 9-pin D-sub connector on the side of the instrument:



- If the 9-pin D-sub connector is set for RS-485 communication, the instrument will not respond to an RS-232 master. In that case, use the [multifunctional switch](#) to enter configuration mode and enable RS-232 communication.
- After configuring the required parameters, follow the same procedure to leave configuration mode and restore the original communication settings (otherwise, configuration mode will remain enabled after the next power-up).

#### Fieldbus2 Address

Type	Access	Range	FlowDDE	FLOW-BUS	Modbus
Unsigned char	RW	0...255	309	124/10	0x0F8A/3979

#### Fieldbus2 Baud Rate

Type	Access	Range	FlowDDE	FLOW-BUS	Modbus
Unsigned long	RW	0...1.0E10	310	124/9	0xFC48...0xFC49/64585...64586

#### Fieldbus2 Parity

Type	Access	Range	FlowDDE	FLOW-BUS	Modbus
Unsigned char	RW	0...2	336	124/12	0x0F8C/3981

The following values are supported:

Value	Description
0	No parity
1	Odd parity
2	Even parity

### 4.2.7 Master/slave configuration (FLOW-BUS)

Normally, there is no communication between the instruments in a fieldbus system. The FLOW-BUS protocol, however, provides a feature to set up a master/slave relationship between two instruments. The typical behavior of a slave instrument is to automatically set its own setpoint relative to the output (measurement value) of its master.

The output value of any instrument in a FLOW-BUS network is automatically available to all other instruments without extra wiring. A slave instrument can also be a master to other instruments.

To set up a master/slave relationship between instruments, set parameter *Control Mode* of the slave instrument to 'FLOW-BUS slave' (value 2) or 'FLOW-BUS analog slave' (value 13), depending on how the setpoint should be calculated.

The slave instrument polls the output value of its master periodically and uses the slave factor to set its own setpoint relative to the master's.



To prevent damage to the instruments an/or the system(s) they are connected to, be sure to avoid circular references between devices on the same fieldbus. The FLOW-BUS system does not have a protection mechanism.

#### Master Node

Type	Access	Range	FlowDDE	FLOW-BUS	Modbus
Unsigned char	RW	1...128	158	33/14	n/a

Sets the master node for the instrument.

Note that this parameter is only effective in a FLOW-BUS network (RS-485).

**Slave Factor**

Type	Access	Range	FlowDDE	FLOW-BUS	Modbus
Float	RW	0...500	139	33/1	0xA108...0xA109/41225...41226

The controller output from the master instrument is multiplied by *Slave Factor*/100 % to get the slave instrument setpoint. In systems other than FLOW-BUS, *Slave Factor* is effective only if *Control Mode* is set to 'Analog slave', and the analog output signal of the master instrument is redirected to the input of the slave instrument.

Example:

- master output = 80 %
  - *Slave Factor* = 50
- ⇒ slave instrument setpoint = 80 % x 50 %/100 % = 40 %

## 4.3 Special features

### 4.3.1 Customized I/O options (pin 5)

**EL-FLOW® Prestige** instruments offer several customized input/output functions through the 9-pin D-sub side connector as an option. I/O options are factory installed as specified at ordering time, and cannot be changed manually.

The last three characters of the model key on the serial number label indicate the installed I/O configuration (see section [Model key](#)). The possible configurations are described in the table below. See the hook-up diagram for custom bus and I/O configurations (document 9.16.118) for an explanation of the codes.

Code	Description
000	Disabled, pin 5 is pulled down to 0 Vdc (default selection)
A1V	0...10 Vdc sourcing output, controller Analog signal for pump or external valve steering (control signal only).  When the controller output is used for pump or external valve steering (only applicable to mass flow meters with the controller function enabled), make sure to set parameter <i>Valve maximum</i> to 0.3 [A]. For mass flow controllers, the controller output signal represents the valve actuator current. This output is limited to a value below 10 Vdc, due to the maximum valve current restriction.
B1V	4...20 mA sourcing output, controller Analog signal for pump or external valve steering (control signal only).  When the controller output is used for pump or external valve steering (only applicable to mass flow meters with the controller function enabled), make sure to set parameter <i>Valve maximum</i> to 0.3 [A]. For mass flow controllers, the controller output signal represents the valve actuator current. This output is limited to a value below 20 mA, due to the maximum valve current restriction.
B2V	3.8...20.8 mA sourcing output, controller Analog signal for Badger Meter valve with TEIP11 signal converter (control signal only)
C3A	Digital output, min/max alarm During a min/max alarm, pin 5 is pulled down to 0 Vdc.
C4A	Digital output, counter alarm During a counter alarm, pin 5 is pulled down to 0 Vdc.
C5S	Digital output, enabled by setpoint (for shut-off control) Pin 5 is pulled down to 0 Vdc at a controller setpoint, e.g. for shut-off valve activation.  For factory selected analog control (...-A#-C5S): If parameter <i>Control mode</i> is set for analog control by factory, the minimum setpoint at which the device (shut-off valve) connected to pin 5 is activated is 1.9%. This prevents possible noise on the analog input activating the device accidentally.

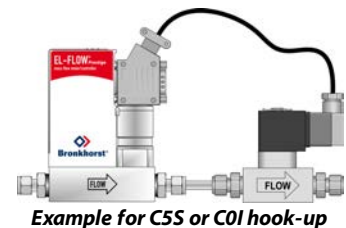

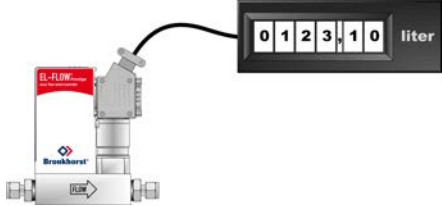
Code	Description
	<p>For factory selected digital control (...-D#-C5S): If parameter <i>Control mode</i> is set for digital control by factory, the setpoint threshold for activating the device connected to pin 5 is any value &gt; 0.</p> <p>Note: If the instrument is forced into Valve Safe State, the digital output is not affected, so a (n/c) shut-off valve connected to pin 5 will not close when the (n/c) controller is in Valve Safe State'</p> <p>Make sure to use 24 Vdc power supply corresponding to the shut-off valve specifications. Cable 7.03.572 (T-part 9-pin D-sub/loose end) or 7.03.603 (T-part 9-pin D-sub/DIN43650C) can be used for this operating option.</p>
C0I	<p>Digital output, high/low switch via remote parameter (e.g. for shut-off valve control) Pin 5 is pulled down to 0 Vdc when writing value 1 to parameter <i>IO switch status</i>, this is undone by writing value 0.</p> <p>A device connected to pin 5 (e.g. a shut-off valve) can be activated/deactivated by writing parameter <i>IO switch status</i>.</p> <p>Note: If the instrument is forced into Valve Safe State, the digital output is also affected, so a (n/c) shut-off valve connected to pin 5 will be closed when the (n/c) controller is in 'Valve Safe State'.</p> <p>Make sure to use 24 Vdc power supply corresponding to the shut-off valve specifications. Cable 7.03.572 (T-part 9-pin D-sub/loose end) or 7.03.603 (T-part 9-pin D-sub/DIN43650C) can be used for this operating option.</p>
D9E	<p>Digital frequency output, measure Measurement value is translated to a frequency within given frequency range.</p> <p>The default frequency range to represent 0...100% flow is 0...10000 Hz. Any other frequency range must be specified on order.</p>
F9B	<p>Digital pulse output, batch counter Pin 5 is pulled down to 0 Vdc when a given batch size is reached (during a given pulse length).</p> <p>By default, a pulse is given at each 1x the <i>Counter unit</i> batch value, with a pulse length of 1 second. For instance, when <i>Counter unit</i> is set to '1n', a pulse is given each time 1 In has passed through the instrument. An alternative pulse length must be specified on order.</p> <p>Provide a pull-up resistor of 5...10 kOhm to create 15...24 Vdc at pin 5 (according to the applicable hook-up diagram).</p> <div style="text-align: right;">  <p><b>Example for F9B hook-up</b></p> </div>
H1P*	<p>4...20 mA input, external pressure sensor for active pressure correction. Signal is translated to parameter <i>Pressure</i>.</p>
I3C	<p>Digital input, controller mode valve close Valve closes when pin 5 is connected to 0 Vdc.</p> <p>This option switches between the default <i>Control mode</i> and mode 'Valve Close' (value 3). When the default <i>Control mode</i> is digital, the default value is 0 (bus/RS232), when the default <i>Control mode</i> is analog, the default value is 1 (Analog input).</p>
I8C	<p>Digital input, controller mode valve purge Valve is fully opened when pin 5 is connected to 0 Vdc.</p> <p>This option switches between the default <i>Control mode</i> and mode 'Valve Fully Open' (value 8). When the default <i>Control mode</i> is digital, the default value is 0 (bus/RS232), when the default <i>Control mode</i> is analog, the default value is 1 (Analog input).</p>

Code	Description
I1R	Digital input, reset counter The counter resets when pin 5 is connected to 0 Vdc.
I2R	Digital input, reset alarm The alarm resets when pin 5 is connected to 0 Vdc.

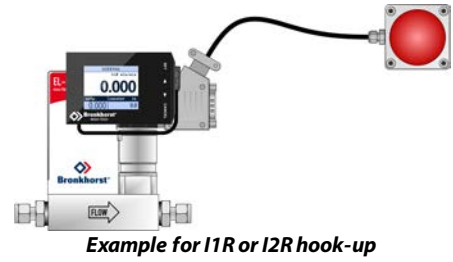

**\*) Note regarding active pressure correction:**

*This option overrides the built-in active pressure correction of the EL-FLOW® Prestige PI.*

### 4.3.2 Changing default control mode

#### IO Status

Type	Access	Range	FlowDDE	FLOW-BUS	Modbus
Unsigned char	RW	0...255	86	114/11	0x0E4B/3660

The instrument is set to accept a setpoint from either an analog or a digital source. Although this setting can be changed with parameter [Control Mode](#), the instrument usually returns to its default control mode at every power-up or reset. The default control mode can be set with parameter *IO Status*; to change it, use the procedures as described below.

Changing from digital operation to analog operation:

1. Set parameter *Init Reset* to 64 (unlocked)
2. Read parameter *IO Status*
3. Add 64 to the read value
4. Write the new value to parameter *IO Status*
5. Set parameter *Init Reset* to 82 (locked)

Changing from analog operation to digital operation:

1. Set parameter *Init Reset* to 64 (unlocked)
2. Read parameter *IO Status*
3. Subtract 64 from the read value
4. Write the new value to parameter *IO Status*
5. Set parameter *Init Reset* to 82 (locked)



*The procedures described above do not change the value of parameter Control Mode. To apply the new default control mode, reset or restart the instrument.*

## 5 Troubleshooting and service



- Electronic problems can be traced by restarting the equipment.
- If the equipment starts up normally, the measurement and control behavior can be checked by applying fluid pressure.
- To track down problems in the fluid system, depressurize the fluid system and disconnect the suspected unit from the process line. Dirt or clogging might be quickly detected by visual inspection of disassembled fluid connections.



If you suspect leakage, do not disassemble the device for inspection, but contact your Bronkhorst representative for service or repairs.

### 5.1 Errors and warnings



See [LED indications](#) for an explanation of the possible LED indications the instrument can give.



In case of problems during operation, error and warning information can be found in FlowDDE and FlowPlot. FlowDDE puts all errors and warnings on the console screen; in FlowPlot, the Alarm & Count tab (Instrument Settings) provides several specific alarm and counter indicators.

### 5.2 Restoring factory settings

In case changes to the instrument configuration leads to non-recoverable erroneous behavior, the instrument can be reset to the pre-configured factory settings. This can be done with the following methods:

- with the multifunctional switch (see [Micro switch functions](#))
- with the *restore* function of a Bronkhorst® readout and control unit (BRIGHT, E-8000)
- via RS232 communication, with the *Restore settings* function in FlowPlot

To restore the factory settings using the multifunctional switch, follow these instructions:

1. Make sure electrical power to the instrument is switched off.
2. Press and hold the multifunctional switch, while powering up the instrument. After 4 seconds, the red LED ● starts flashing (0.2 seconds on, 0.2 seconds off).
3. At that moment (which is after 4 to 8 seconds), release the switch.



Changes made to the network settings (bus address, baud rate, parity) will **not** be restored by a factory reset.



If digital communication with the instrument can not be re-established, see [Micro switch functions](#) to overrule the actual 9-pin D-sub communication settings with the configuration mode and use the RS232 communication mode to re-establish communication.

### 5.3 Common issues

Symptom	Possible cause	Action
No power (LEDs not burning)	No power supply	Check power supply
		Check cable connection
Zero output signal	Internal fuse blown due to long lasting shortage	Return to factory
	No setpoint accepted, incorrect control mode	Check analog/digital control mode (see section <a href="#">Special parameters</a> )
	No setpoint given, setpoint too low	Give setpoint >2%
	Valve in 'Safe State' (normally closed valves)	Remove cause of 'Valve Safe State' (see section <a href="#">Valve Safe State</a> )
	Pcb/sensor failure	Return to factory
Maximum output signal (131.07%)	Laminar flow element blocked/contaminated	Return to factory
	Flow too high, valve fully open	Close valve
	Pcb/sensor failure	Return to factory
Setpoint cannot be achieved	Valve in 'Safe State' (normally open valves)	Remove cause of 'Valve Safe State' (see section <a href="#">Valve Safe State</a> )
	Pressure difference across instrument insufficient to achieve requested flow rate	Check inlet/outlet pressure
	Valve blocked or damaged	Return to factory
Flow signal is gradually decreasing without setpoint change	Stoppage	Remove contamination
	Pressure difference across instrument insufficient to achieve requested flow rate	Check inlet/outlet pressure
Oscillating controller output	Process gas condensation occurs	Decrease pressure or increase gas temperature
	Controller adjustment wrong, PID settings too fast	Decrease <a href="#">Controller Speed</a> value
	Inlet/outlet pressure too high or too low	Adjust pressure/set correct instrument pressure with FlowTune™
	Wrong gas selected	Set correct process gas with FlowTune™
	Inlet pressure control is oscillating	Replace pressure regulator or increase buffer volume between controlling instruments (see section <a href="#">Piping requirements</a> )
	'Cross-talk' with other controller instruments in process line	Increase buffer volume between controller instruments (see section <a href="#">Piping requirements</a> )
Non-zero output signal when valve is closed	Valve is damaged	Return to factory
	Valve is leaking (through valve)	Check valve specifications for leak-tightness through valve
	Non-zero offset signal (occurs at upward/downward placement at higher pressures)	See <a href="#">Adjusting zero point</a>

## 5.4 Service

For current information about Bronkhorst® and worldwide service addresses, please visit our website:

 [www.bronkhorst.com](http://www.bronkhorst.com)

Do you have any questions about our products? Our Sales department will gladly assist you selecting the right product for your application. Contact sales by e-mail:

 [sales@bronkhorst.com](mailto:sales@bronkhorst.com)

For after-sales questions, help and guidance, our Customer Care department is available by e-mail:

 [aftersales@bronkhorst.com](mailto:aftersales@bronkhorst.com)

No matter the time zone, our experts within the Customer Care department are available to answer your request immediately or take appropriate further action. Our experts can be reached at:

 **+31 859 02 18 66**

Bronkhorst High-Tech B.V.  
Nijverheidsstraat 1A  
NL-7261 AK Ruurlo  
The Netherlands



## 6 Returns

### 6.1 Removal and return instructions

When returning materials, always clearly describe the problem, and, if possible, the work to be done, in a covering letter.

#### Instrument handling:

1. Purge all fluid lines (if applicable)
2. If the instrument has been used with toxic or otherwise hazardous fluids, it must be cleaned before shipping
3. Disconnect all external cabling and tubing and remove the instrument from the process line
4. If applicable, secure movable parts with appropriate transport safety materials, to prevent damage during transportation
5. The instrument must be at ambient temperature before packaging
6. Insert the instrument into a plastic bag and seal the bag
7. Place the bag in an appropriate shipping container; if possible, use the original packaging box

#### Add documentation:

- Reason of return
- Failure symptoms
- Contaminated condition
- Declaration on decontamination



***It is absolutely required to notify the factory if toxic or dangerous fluids have been in contact with the device!***  
*This is to enable the factory to take sufficient precautionary measures to safeguard the staff in their repair department.*

*All instruments must be dispatched with a completely filled in 'Declaration on decontamination'. Instruments without this declaration will not be accepted.*



*A safety information document containing a 'Declaration on decontamination' form (document no 9.17.032) can be downloaded from the **Service & Support** section of the Bronkhorst website ([www.bronkhorst.com](http://www.bronkhorst.com)).*

#### Important:

Clearly note, on top of the package, the customs clearance number of Bronkhorst High-Tech B.V.:

**NL801989978B01**

(only if applicable, otherwise contact your Bronkhorst representative for local arrangements.)

### 6.2 Disposal (end of lifetime)

If you are a customer within the European Union and wish to dispose of Bronkhorst® equipment bearing the symbol of a crossed out waste disposal bin, you can return it in accordance with the [removal and return instructions](#). Bronkhorst will then take care of proper dismantling, recycling and/or reuse (wherever possible). In the covering letter, mention that you are returning the product for disposal.

In countries outside the EU, disposal of electrical and electronic equipment (EEE) may be subject to local or national directives and/or legislation. If applicable, consult local or national authorities to learn how to handle EEE properly in your area.





## Parameter index

### Parameters

		Mix Fraction Type	45
		Mix Volume Pressure	45
		Mix Volume Temperature	45
		Parameters - Master/Slave	
		Master Node	50
		Slave Factor	51
		Parameters - Measurement and control	
		Analog Input	40
		Fmeasure	40
		Fsetpoint	40
		Measure	35
		Pressure	36
		Sensor Type	40
		Setpoint	36
		Setpoint Slope	40
		Temperature	36
		Valve Output	40
		Parameters - Network configuration	
		Fieldbus1 Address	49
		Fieldbus1 Baud Rate	49
		Fieldbus1 Parity	49
		Fieldbus2 Address	50
		Fieldbus2 Baud Rate	50
		Fieldbus2 Parity	50
		Parameters - Special	
		Control Mode	41
		Init Reset	41
		IO Status	53
		Reset	41
		Wink	41
Parameters - Alarms			
Alarm Delay Time	46		
Alarm Info	46		
Alarm Maximum Limit	47		
Alarm Minimum Limit	47		
Alarm Mode	46		
Alarm New Setpoint	47		
Alarm Setpoint Mode	47		
Reset Alarm Enable	47		
Parameters - Counter			
Counter Limit	48		
Counter Mode	48		
Counter New Setpoint	49		
Counter Setpoint Mode	49		
Counter Unit	48		
Counter Value	48		
Reset Counter Enable	49		
Parameters - Device identification			
BHT Model Number	37		
Customer Model	36		
Device type	37		
Firmware version	37		
Identification number	37		
Serial Number	36		
User Tag	36		
Parameters - Fluid set			
Capacity 100%	43		
Capacity Unit	43		
Capacity Unit Type Pressure	44		
Capacity Unit Type Temperature	43		
Controller Speed	44		
Fluid Name	43		
Fluid Set Index	43		
Parameters - Fluid set (advanced)			
Density	44		
Fluid Temperature	44		
Heat Capacity	44		
Inlet Pressure	44		
Outlet Pressure	44		
Thermal Conductivity	44		
Viscosity	45		
Parameters - Fluid set (mixture)			
Mix Component Fluid Name	45		
Mix Component Fraction	45		
Mix Component Index	45		